



Hanover / 387

hanoveryachts.com / 2025



First impressions matter, but with the Hanover 387, you have nothing to worry about. Its striking Hard-Top, wide beam, and spacious design offer unmatched comfort on deck and in the cabin. With premium amenities and elegant details, you can relax and sleep comfortably, making every voyage unforgettable.

Hanover 387

AFT & COCKPIT



Hanover 387

2025

GALLEY, CABINS, & HEAD.

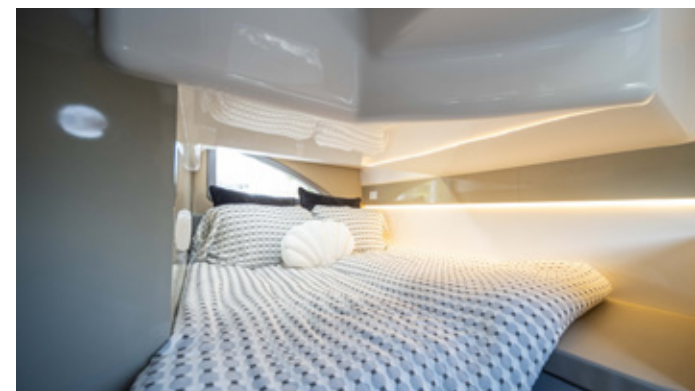

Hanover 387

2025

BOW & STERN.

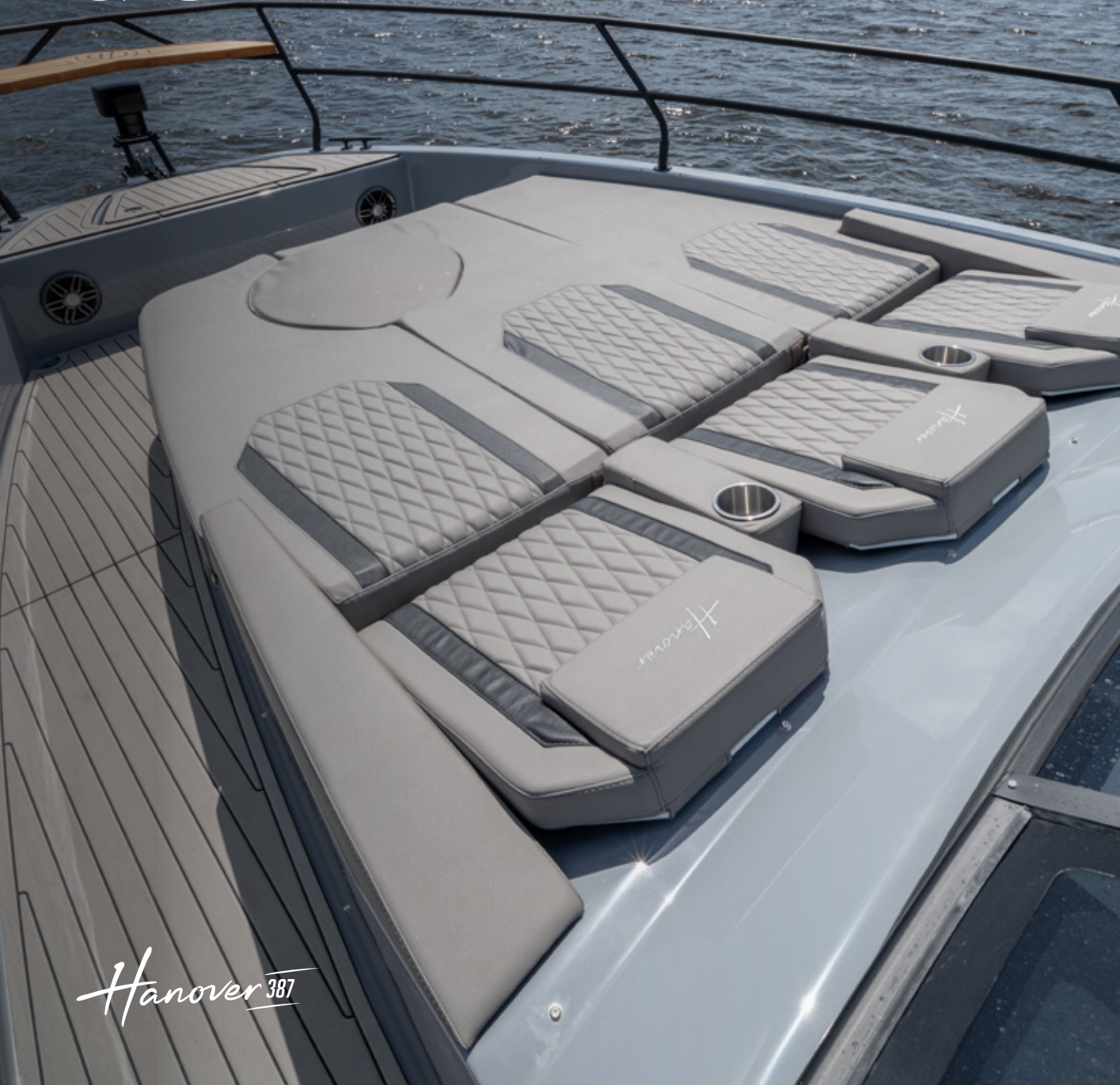

Hanover 387

2025

TECHNICAL SPECIFICATIONS



LENGTH

Outboards: 38' 10" / 11.85 m
Inboards: 37' 3" / 11.35 m



BEAM

10' 10" / 3.30 m



DRAFT

33" / 0.8 m



DRY WEIGHT

15,220 lbs / 6,904 kg



FUEL TANK CAPACITY

265 gal / 946 L



WATER TANK CAPACITY

50 gal / 190 L



HOLDING TANK

20 gal / 75 L



CAPACITY

15 day / 5 Night



CRUISING SPEED

22-24 mph / 31.3 kph



WIDE OPEN THROTTLE

43-45 mph / 69.2-72.4 kph



DEADRISE

16°



BRIDGE CLEARANCE

10' 7" / 3.2 m
12' 7" / 3.8 m with radar
or anchor light



Hanover 387

2025

HULL AND COCKPIT

- 1 bow eye
- 2 Stainless steel handrail with teak seat in the bow
- 3 20" hatch in the bow from cabin to bow area
- 4 4 panoramic tempered glass windows
- 5 2 tilting tempered glass windows in the cockpit
- 6 Tempered glass windshield and anodized aluminum frame
- 7 4-step telescopic ladder on platform
- 8 Triple bow solarium with adjustable backrest
- 9 Handle stainless steel in the gourmet space

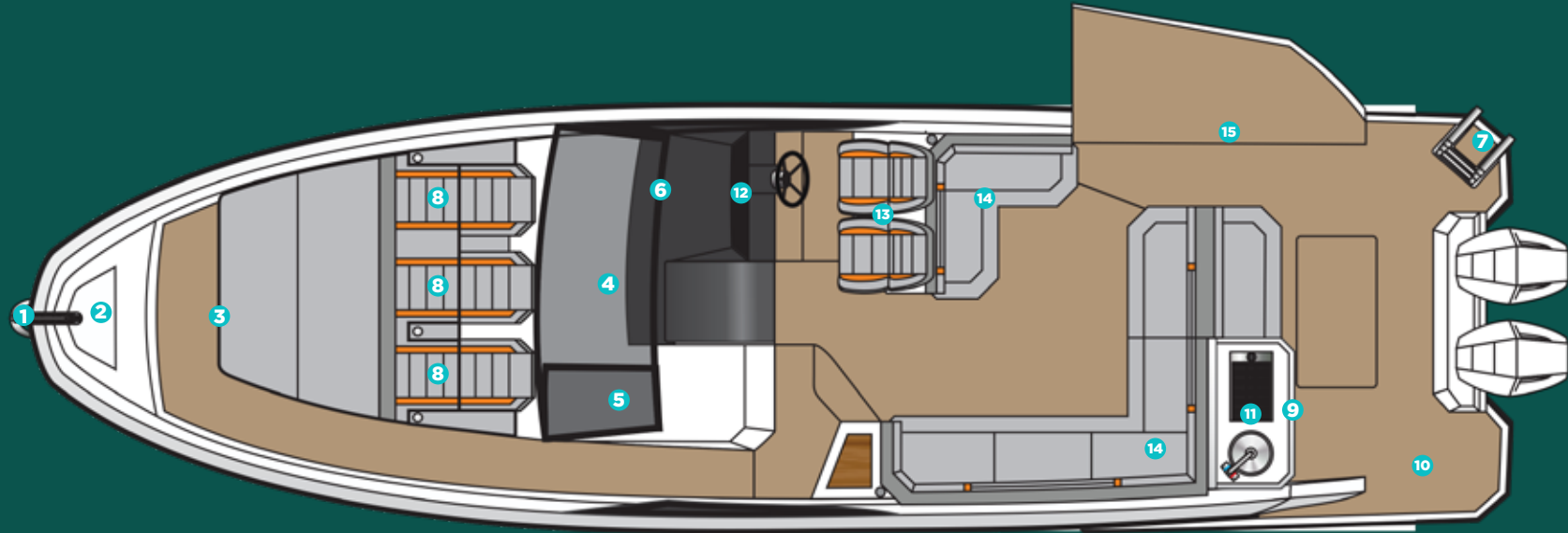

- 10 Teak table
- 11 Gourmet space with top lid and sink
- 12 Instrument panel that supports up to two 9" electronics with built-in compass
- 13 Dual rider seat with standing or sitting
- 14 Two L-shaped sectional sofa in the cockpit and another in the stern
- 15 Electric Opening Lateral Deck - Beach Club System

A CABIN

- 1 Kitchen with sink, synthetic granite top, space for microwave, induction stove, fridge, 3 drawers and two cabinets
- 2 Stainless steel staircase with 3 wide teak steps
- 3 Acrylic access sliding door with lock and key
- 4 High Quality Laminate Flooring
- 5 Decorative mirror on the bow
- 6 U-shaped sofa for 3 people that converts into a double bed, with teak retractable table
- 7 Double bed in the middle ship cabin
- 8 Sofa in the middle ship cabin
- 9 Free standing up of 9' in cabin center

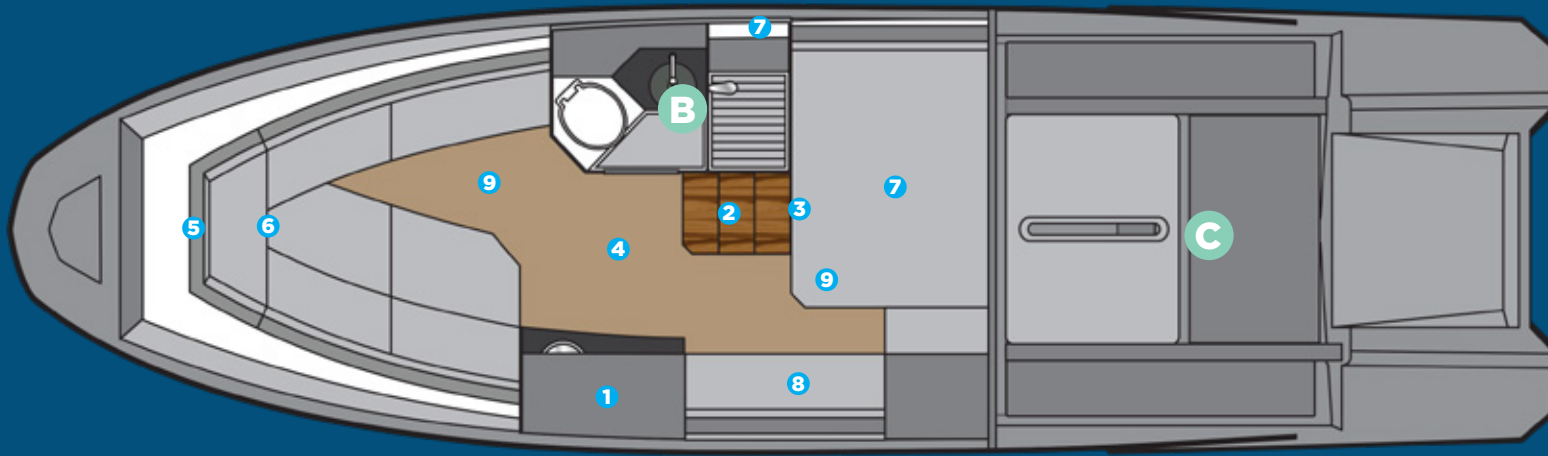

B HEAD

- Electric toilet with 22 gallon waste box, macerator pump and external nozzle
- Cabinet with two doors, sink in synthetic granite with bowl overlaid in tempered glass
- Air cabinet with two mirrored doors
- Decorative coating with glass inserts
- Shower box free standing height 6'2" /1,88 min
- Tempered glass box
- Shower with mixer
- Non-slip floor

C ENGINE

- Interior in gray gelcoat
- Non-slip sole, flat
- Insulation, acoustic and thermal
- Fire extinguisher
- Compartment, sealed, for air conditioning
- Compartment, sealed, for batteries
- Exhaust fans (2)
- Engine room hatch
- Access door with gas pistons and lock
- Fuel tank, aluminum, with level gauge

**CUSTOMIZE
AND HAVE
THE MOST
UNIQUE
VESSEL
AT SEA.**



Hanover 387

2025



EXTERIOR PAINT OPTIONS

All options are available in either a high-gloss or matte finish.

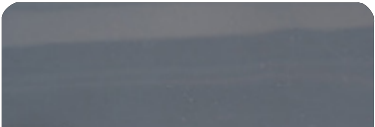

Moonstone Gray



Pure Gray

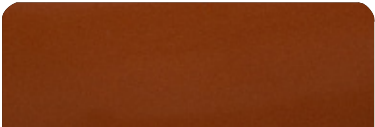

Orange Pearl



Spring Blue



Orkney Gray



Ice Silver



Moscou Red



Heraldic Blue

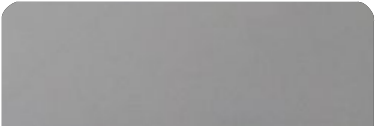

Crayon Gray

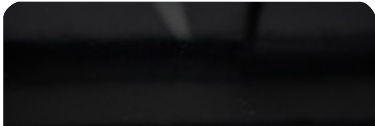

Gales Black (Tuxedo)

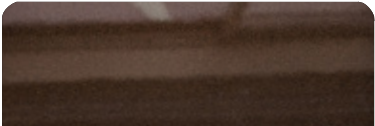

Marrakesh Brown



Macaw Blue



UPHOLSTERY OPTIONS



Fern



Terracota



Caramello

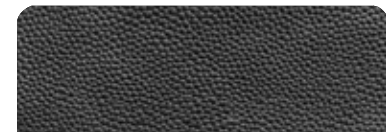

Black

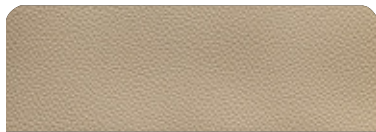

Land Rover



Taupe

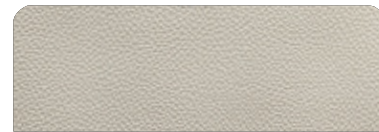

Ivory



Orange

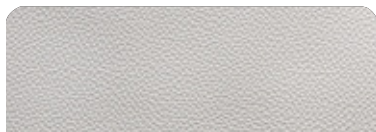

Off White

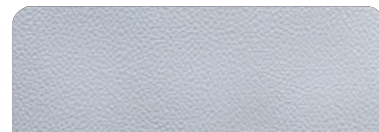

Gray

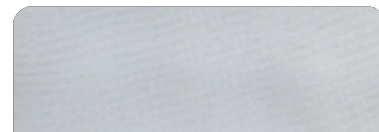

Silver

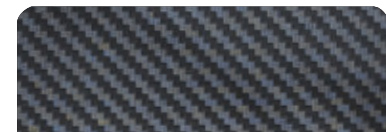

Carbon Fiber



White

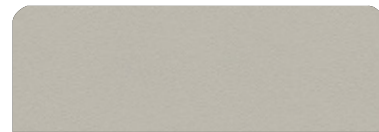

Beige

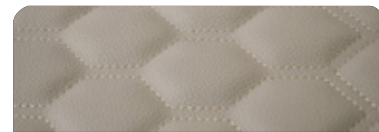

Matelasse Honeycomb



New Corolla



Blue

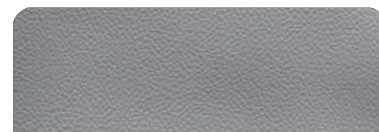

Corolla

Hanover 387

*Additional options are available upon request.

2025



FURNITURE VINYL OPTIONS



Salina



Massal

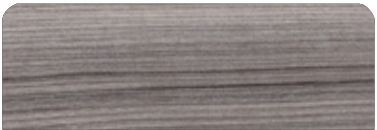

Cherry



Patina

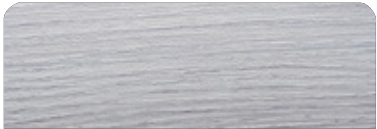

Alder



Bronze



Freije

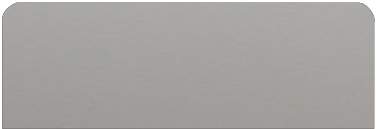

Taupe Super Matte

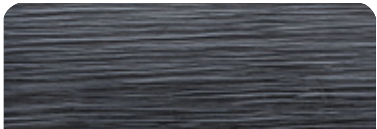

Black Line

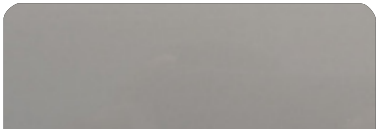

Taupe High Gloss

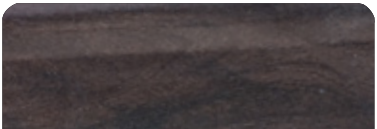

Canyon

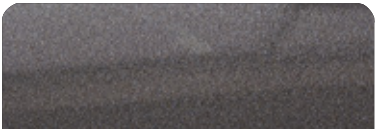

Onix



Metallic



Gray Oak



INTERIOR FLOORING OPTIONS



Alba



Almond



Pine



Amendola



Sand



Cement



Imbuia



Cumaru



Gray



Duna



Vintage



Kashmir



DECK FLOORING OPTIONS

PATTERNS

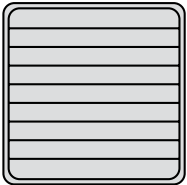

Classic

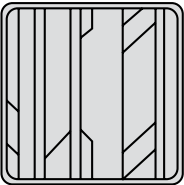

Aztec

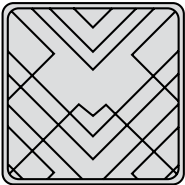

Imperial

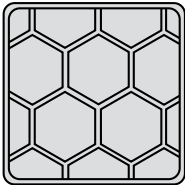

Beehive

EVA

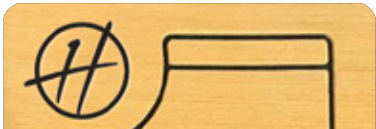

Madeira



Gray

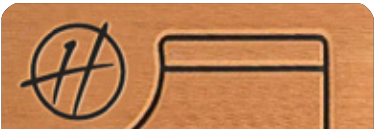

Ocher

SYNTHETIC TEAK



Madeira



Gray



Sand

STANDARD EQUIPMENT

HULL AND DECK

- 8" through bolted stainless steel cleats (06 count)
- 1 bow eye
- 2 eyes at the stern
- Stainless steel handrail with teak seat in the bow
- Self-draining floor
- 20" hatch in the bow from cabin to bow area
- 4 panoramic tempered glass windows
- 2 tilting tempered glass windows in the cockpit
- Tempered glass windshield and anodized aluminum frame
- 4-step telescopic ladder on platform
- Double bow solarium with adjustable backrest
- Handle stainless steel in the gourmet space
- Compartment for fenders on the platform floor
- 5 compartments below the cockpit seats
- Teak table
- Upholstery in anti-mold leather
- Gourmet space with top lid, sink, fridge, cutting board
- Hard-Top
- Storage, acrylic
- Acrylic cup holder in the cockpit
- Instrument panel that supports up to two 9" electronics with built-in compass
- Dual rider seat with standing or sitting
- Two seating areas in the cockpit
- Cooler
- Garbage Displacement
- Electric Opening Lateral Deck - Beach Club System

HEAD

- Electric toilet with 22 gallon waste box, macerator pump and external nozzle
- Cabinet with two doors, sink in synthetic granite with bowl overlaid in tempered glass
- Air cabinet with two mirrored doors
- Decorative coating with glass inserts
- Shower with mixer
- Tempered glass box
- Shower box free standing height 6'2" /1,88 m
- Non-slip floor

CABIN

- Acrylic access sliding door with lock and key
- Stainless steel staircase with 3 wide teak steps
- Ultra moisture resistant MDF furniture
- Kitchen with sink, synthetic granite top, space for microwave, induction stove, fridge, 3 drawers and two cabinets
- High Quality Laminate Flooring
- Decorative mirror on the bow
- U-shaped sofa for 3 people that converts into a double bed, with teak retractable table
- Double bed in the middle ship cabin
- Sofa in the middle ship cabin
- Coverings in waterproof fabric or anti-mold nautical leather
- Side walls covered with anti-mold foam and nautical leather
- Luxury layette kit with 10 pillows
- Free standing up of 9' in cabin center

ENGINE ROOM

- Interior in gray gelcoat
- Non-slip sole, flat
- Insulation, acoustic and thermal
- Fire extinguisher
- Compartment, sealed, for air conditioning and batteries
- Exhaust fans (2)
- Engine room hatch
- Access door with gas pistons and lock
- Fuel tank, aluminum, with level gauge

PUMPS AND TANKS

- Water tank, potable, 50 gal
- Fresh water pump
- Bilge pumps, engine room, with automatic switches
- Bilge pump, amidships, with automatic switch
- Collection box for shower with pump
- Showerhead, aft, with mixer

ELECTRICAL

- Circuit breaker board
- Selector switch for pier/generator/inverter
- Electrical panel in the cockpit with special switches
- Navigation lights
- Anchoring lights
- Indirect LED lighting on the cockpit ceiling, bathroom, cabin, cabinet and under the sofas and dashboard
- LED spotlights on the cabin and cockpit ceiling
- Lighting in the engine room
- 120v sockets in the cockpit, cabin and bathroom
- 12v / USB sockets on the dashboard and in the cabin
- Shore power socket
- Individual master switches for accessory batteries and motors

OPTIONS INCLUDED

- Synthetic teak or EVA on bow, cockpit and swim platform
- Sound system
- Anchor Windlass Electric System
- Anchor, 22 lbs, with chain
- VHF Radio w/ Antenna
- Sunroof, electric opening
- Holding tank with macerator
- Air conditioning, 12,000 BTU
- Generator
- Refrigerator,
- Trim tabs, electric
- Spotlights
- Shorepower
- Gourmet Area

The image shows two Mercury Verado outboard motors mounted on the stern of a boat. The motors are white with blue accents and the Mercury logo. The background is a dark, overcast sky and blue water with a wake. The text 'OUTBOARD & INBOARD OPTIONS' is overlaid in white on the left side.

OUTBOARD & INBOARD OPTIONS

Hanover 387

2025

2025 HANOVER 387

OUTBOARD ENGINES

ESSENTIAL PACKAGE

PREMIUM PACKAGE

Engine	Twin Mercury® VERADO 300hp V8 w/ Joystick Piloting	Twin Mercury® VERADO 350hp V10 w/ Joystick Piloting
GPS	GPS SIMRAD® Go7 (7")	GPS SIMRAD® Go9 (9")
Exterior Painting	1 Color (Hull)	2 Colors or More (Hull, Deck or HT)
A/C	12,000 BTU (Cabin)	12,000 + 6,000 BTU (Cabin - Cockpit)
Refrigerator	79L Refrigerator - 110V	Isotherm® 65L Fridge 12V
VHF Radio	Uniden® VHF Radio w/ Antenna	SIMRAD® VHF Radio w/ Antenna
Power Generator	Kohler® 6KW	Kohler® 9KW
Sound System	Boss Sound Kit + 6 JBL Marine Speakers + Amplifier	Fusion® Marine Sound Kit + 6 Marine Speakers + Amplifier
Electric Trim Tabs (Flaps)	✓	✓
Headlights With Remote (Cruising Spotlight)	✓	✓
EVA Flooring (Cockpit, Platform, Bow)	✓	✓
Electric Anchor Windlass System - 1000w + 10kg Anchor And 40m Chain (35+)	✓	✓
Windshield Wipers	✓	✓
Macerator Pump And Holding Tank	✓	✓
Shore Power System	✓	✓
Shore Power Cord 50A	✓	✓
Power Charger 100A	✓	✓
Heavy Duty Folding Table (Cockpit)	✓	✓
Galvanic Isolator (Electrical Protection)	✓	✓
Lines & Fenders	✓	✓
USCG Boating Safety Kit	✓	✓
Italian Steering Wheel		✓
Hot Water System - Heater (Shower)		✓
Induction Electric Stove (Cabin)		✓
LED 24" TV Set And Mounting		✓
Upholstered Stools/Chairs On Stern (Kit Of 2 Banquets)		✓
Teak Table On Stern (Platform Extra Table)		✓
Design Items Set (Pillows, Bedding, Cushions, Towels, Accessories)		✓

\$477,845

\$519,375

2025 HANOVER 387

INBOARD ENGINES

ESSENTIAL PACKAGE

PREMIUM PACKAGE

Engine	Twin Mercury® Mercruiser Axis 300hp W/ Joystick Piloting	Twin Mercury® Mercruiser Axis 350hp W/ Joystick Piloting
GPS	GPS SIMRAD® Go7 (7")	GPS SIMRAD® Go9 (9")
Exterior Painting	1 Color (Hull)	2 Colors or More (Hull, Deck or HT)
A/C	12,000 BTU (Cabin)	12,000 + 6,000 BTU (Cabin - Cockpit)
Refrigerator	79L Refrigerator - 110V	Isotherm® 65L Fridge 12V
VHF Radio	Uniden® VHF Radio w/ Antenna	SIMRAD® VHF Radio w/ Antenna
Power Generator	Kohler® 6KW	Kohler® 9KW
Sound System	Boss Sound Kit + 6 JBL Marine Speakers + Amplifier	Fusion® Marine Sound Kit + 6 Marine Speakers + Amplifier
Electric Trim Tabs (Flaps)	✓	✓
Headlights With Remote (Cruising Spotlight)	✓	✓
EVA Flooring (Cockpit, Platform, Bow)	✓	✓
Electric Anchor Windlass System - 1000w + 10kg Anchor And 40m Chain (35+)	✓	✓
Windshield Wipers	✓	✓
Macerator Pump And Holding Tank	✓	✓
Shore Power System	✓	✓
Shore Power Cord 50A	✓	✓
Power Charger 100A	✓	✓
Heavy Duty Folding Table (Cockpit)	✓	✓
Galvanic Isolator (Electrical Protection)	✓	✓
Lines & Fenders	✓	✓
USCG Boating Safety Kit	✓	✓
Italian Steering Wheel		✓
Hot Water System - Heater (Shower)		✓
Induction Electric Stove (Cabin)		✓
LED 24" TV Set And Mounting		✓
Upholstered Stools/Chairs On Stern (Kit Of 2 Banquets)		✓
Teak Table On Stern (Platform Extra Table)		✓
Design Items Set (Pillows, Bedding, Cushions, Towels, Accessories)		✓

\$448,845

\$481,375



BUILD YOUR BOAT.

Choose Upgrades
Tailored to Your Lifestyle.

LAYOUT OPTIONS

Aft-Grill

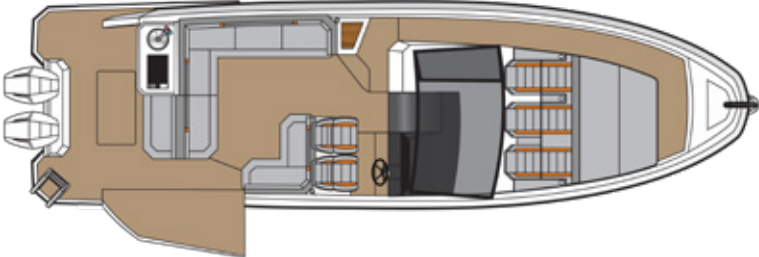

Starboard Kitchen and Aft-Grill

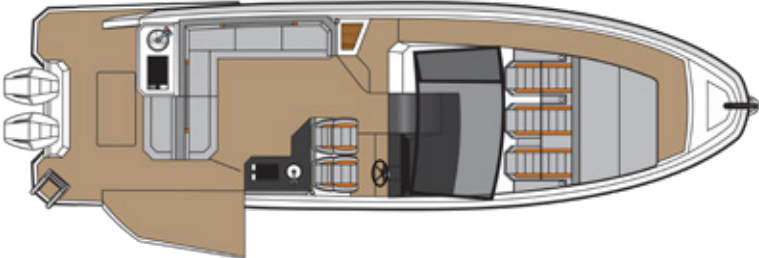

Aft-Sundeck

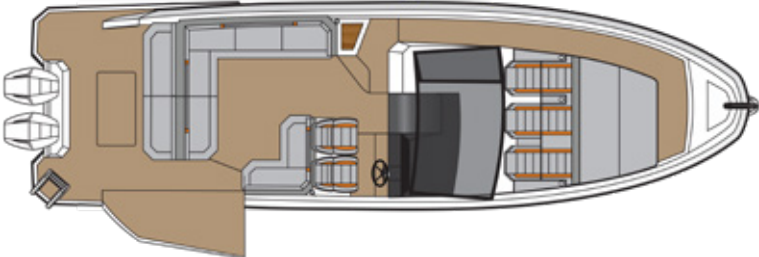

Starboard Kitchen and Aft-Sundeck

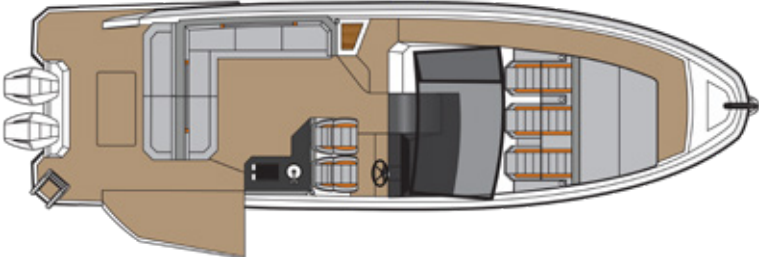

BUILD YOUR BOAT BY SELECTING ITEMS FROM THE LIST BELOW



ENGINES

INBOARD

MERCURY TWIN MERCUISER AXIUS 300HP W/ JOYSTICK PILOTING
MERCURY TWIN MERCUISER AXIUS 350HP W/ JOYSTICK PILOTING
MERCURY TWIN MERCUISER AXIUS 380HP W/ JOYSTICK PILOTING
MERCURY TWIN MERCUISER AXIUS 320HP - DIESEL W/ JOYSTICK PILOTING
MERCURY TWIN MERCUISER AXIUS 350HP - DIESEL W/ JOYSTICK PILOTING
VOLVO TWIN D4 320HP DIESEL
VOLVO TWIN D6 380HP DIESEL

OUTBOARD

MERCURY TWIN VERADO 300HP V8 OUTBOARDS W/ JOYSTICK PILOTING
MERCURY TWIN VERADO 350HP V10 OUTBOARDS W/ JOYSTICK PILOTING
MERCURY TWIN VERADO 400HP V10 OUTBOARDS W/ JOYSTICK PILOTING



PAINT

EXTERNAL SINGLE PAINTING (1 COLOR, HULL)
EXTERNAL DOUBLE PAINTING (2 OR MORE COLORS, HULL, DECK OR HT)
EXTERNAL COMPLETE SPECIAL PAINT AND OR SPECIAL COLOR SELECTION
BOTTOM PAINT - ANTIFOUL COPPERCOAT PAINT (415)



NAVIGATION

ELECTRIC TRIM TABS (FLAPS)
HUMPHREE AUTOMATIC TRIM TABS
ZIP WAKE AUTOMATIC TRIM TABS
HEAD LIGHTS WITH REMOTE (CRUISING SPOTLIGHT)
BOW THRUSTERS
MC² QUICK GYRO STABILIZERS (X10)
FLIR NIGHT VISION
ITALIAN STEERING WHEEL



FLOORING

EVA FLOORING (COCKPIT, PLATFORM, BOW)
SYNTHETIC TEAK FLOORING (COCKPIT, PLATFORM, BOW)
REAL TEAK FLOORING (COCKPIT, PLATFORM, BOW)



AUDIO

BOSS SOUND KIT + 6 JBL MARINE SPEAKERS + AMPLIFIER
FUSION MARINE SOUND SYSTEM KIT + 6 MARINE SPEAKERS + AMPLIFIER
JBL MARINE SUBWOOFER
JBL MARINE AMPLIFIER (EXTRA) (2 CHANNELS)
FUSION MARINE AMPLIFIER (EXTRA) (2 CHANNELS)
JBL MARINE SPEAKERS (EXTRA PAIR)
JL AUDIO KIT 1 - MEDIA MASTER + 6 SPEAKERS + AMP
JL AUDIO KIT 2 - MEDIA MASTER + 8 SPEAKERS + AMP + SUBWOOFER



ELECTRONICS

GPS RAYMARINE ELEMENT 7S (7")
GPS RAYMARINE AXIOM 9"
GPS RAYMARINE AXIOM 12"
GPS SIMRAD Go7 (7")
GPS SIMRAD Go9 (9")
GPS SIMRAD NSS 10" EVO4 (10")
GPS SIMRAD NSS12 (12")
GPS SIMRAD NSX15 ULTRAWIDE (15")
GPS SIMRAD NSS16 (16")
GPS GARMIN 9"
GPS GARMIN 12"
MERCURY VESSEL VIEW 4"
MERCURY VESSEL VIEW 7"
MERCURY VESSEL VIEW 9"
SIMRAD RADAR HALO20+
RAYMARINE RADAR QUANTUM II
GARMIN RADAR
UNIDEN VHF RADIO W/ ANTENNA
SIMRAD VHF RADIO W/ ANTENNA



GENERATOR

KOHLER 6KW POWER GENERATOR
KOHLER 9KW POWER GENERATOR
KOHLER 11KW POWER GENERATOR



COVERS

SET OF WEATHERIZED EXTERIOR SEAT COVERS
SNAP-ON CANVAS COVER
EISENGLASS ENCLOSURE



AIR CONDITIONING

A/C SYSTEM - 6,000 BTU (COCKPIT)
A/C SYSTEM - 9,000 BTU (COCKPIT)
A/C SYSTEM - 12,000 BTU (CABIN)
A/C SYSTEM - 16,000 BTU (CABIN)



UTILITIES

ELECTRIC ANCHOR WINDLASS SYSTEM - 1000W + 10KG ANCHOR AND 40M CHAIN (35+)
WINDSHIELD WIPERS
MACERATOR PUMP AND HOLDING TANK
HOT WATER SYSTEM - HEATER (SHOWER)
SHORE POWER SYSTEM
SHORE POWER CORD 50A
POWER CHARGER 100A
POWER CHARGER/INVERTER 1800W
POWER CHARGER/INVERTER 3000W
INDUCTION ELECTRIC STOVE (CABIN)
MICROWAVE OVEN
79L REFRIGERATOR - 110V
ISOTHERM 65L FRIDGE 12V
REFRIGERATED 12V DRAWER (COCKPIT)
ISOTHERM ICE MAKER
KENYON ELECTRIC GRILL (STERN)
LED 24" TV SET AND MOUNTING
USCG BOATING SAFETY KIT
LINES & FENDERS



COMFORT & DESIGN

- WOODEN STOOLS/CHAIRS ON STERN (KIT OF 2 BANQUETS)
- UPHOLSTERED STOOLS/CHAIRS ON STERN (KIT OF 2 BANQUETS)
- TEAK TABLE ON STERN (PLATFORM EXTRA TABLE)
- HEAVY DUTY FOLDING TABLE (COCKPIT)
- BOW TENT (BIMINI TOP ON BOW)
- HYDRAULIC UNDERWATER SWIM PLATFORM (INBOARDS ONLY)
- CERAMIC MARBLE DECORATIVE WALL (HEAD)
- MID SHIP CABIN ROOM ENCLOSURE (WOOD/DOOR)
- MAIN CABIN ROOM ENCLOSURE (WOOD/DOOR)
- MANUAL AFT SHADE (STOBAG)
- ELECTRIC AFT SHADE (STOBAG)
- ITALIAN PREMIUM UPHOLSTERY
- LEATHER COVER PANEL (COMPLETE DASHBOARD & HELM)
- ADJUSTABLE SINGLE SEAT - MANUAL
- ADJUSTABLE SINGLE SEAT - ELECTRIC
- LED MIRROR UPGRADE (BATHROOM)
- BLACK EXTERIOR RAILING
- DESIGN ITEMS SET (PILLOWS, BEDDINES, CUSHIONS, TOWELS, ACCESSORIES)



ADDITIONAL UPGRADES

- UNDERWATER LIGHTS (PAIR)
- RGB CHANGING LIGHTS (COCKPIT)
- GALVANIC ISOLATOR (ELECTRICAL PROTECTION)
- FIREBOY - ADVANCED FIRE SUPPRESSION SYSTEM
- LIVWELL (COCKPIT)
- ADJ ENGINE PROTECTION RAILING W/ ROD HOLDERS
- ADJ ENGINE PROTECTION RAILING
- PPF (PAINT PROTECTION FILM)
- YACHT CONTROLLER
- STARLINK
- ADDTL USB / ELECTRICAL OUTLETS
- REMOVABLE LADDER (BEACH CLUB)



For Pricing and more Options
Contact us now:



www.hanoveryachts.com



sales@hanoveryachts.com



+1 954-355-9204



+1 (305) 452-0002

SHIPPING DIMENSIONS

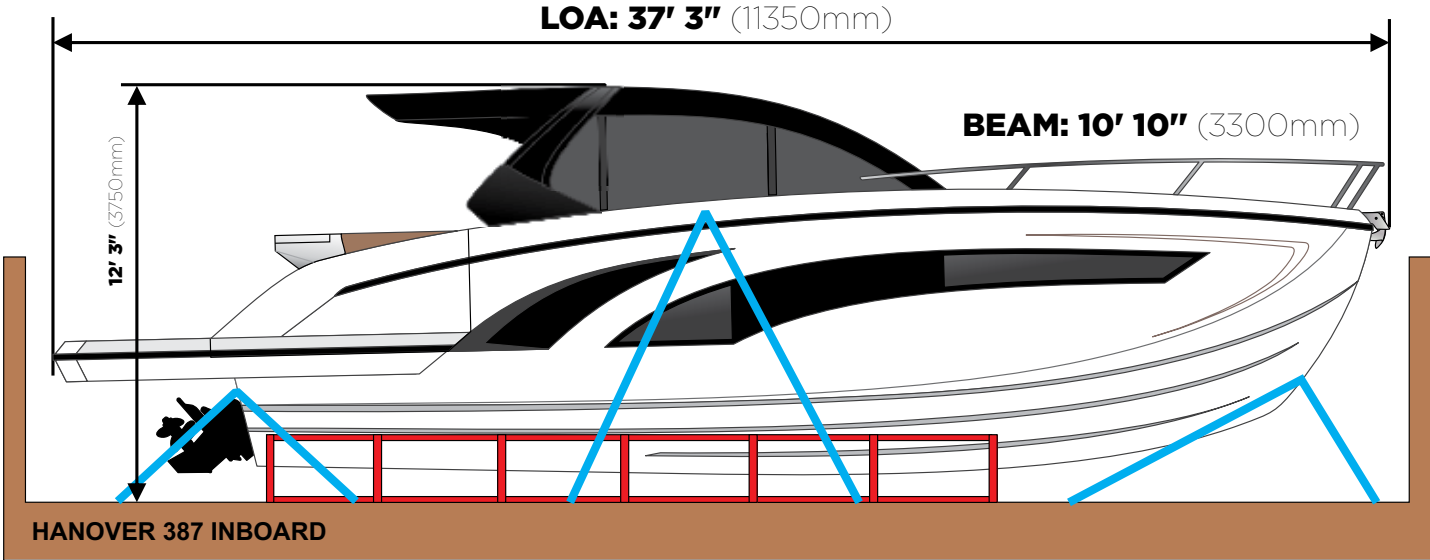
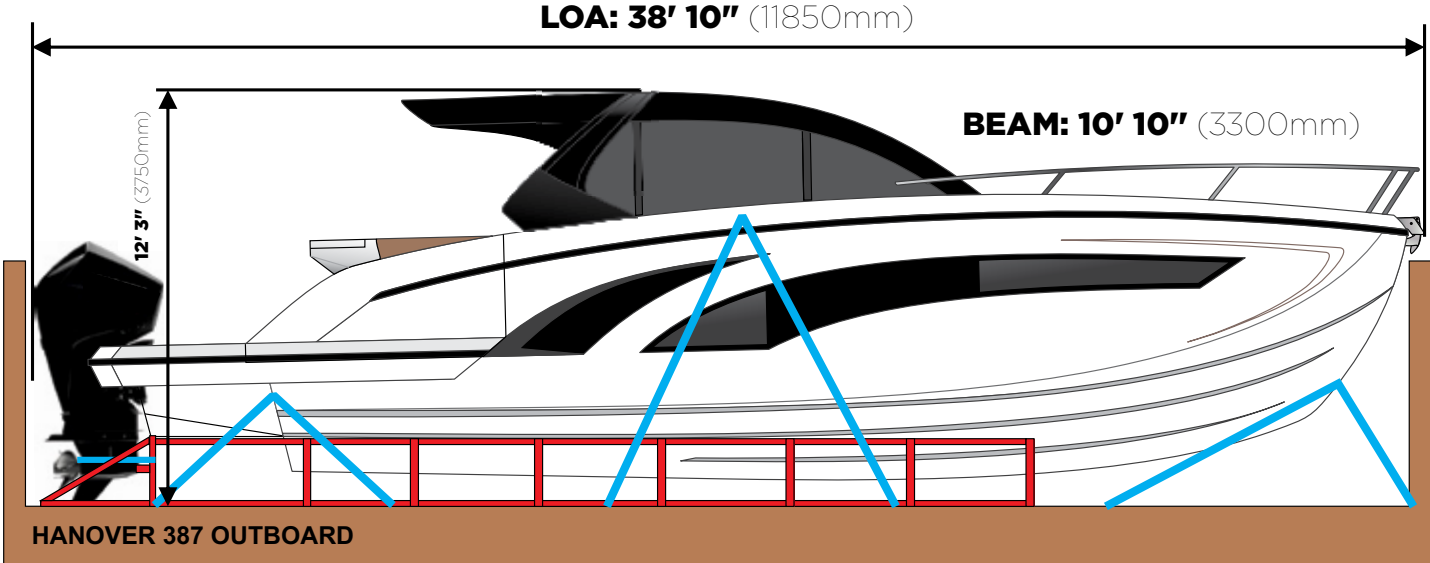

HANOVER OWNERSHIP PROGRAM

At Hanover, we ensure an exciting stress-free experience from the moment you discover our brand.

STRESS-FREE PRICING

Our entire lineup comes at our lowest price - no haggling needed. Leave the negotiations to used car salesmen, and enjoy a straightforward buying experience with us.

FIRST TRIP

We've got you covered! You'll receive thorough training, and a captain will accompany you until you feel fully confident at the helm. Enjoy the experience like a pro!

MAINTENANCE AND WARRANTY

Every Hanover vessel includes a 5-Year Premier Level Hull Warranty, 1 Year General, Mechanical and Components Warranty, All Accessories & Electrical Parts Under The Original Manufacturer's Warranty.

Cruise with complete confidence knowing you have a team of dedicated professionals at your service.

Don't just own a boat, be part of the Hanover Lifestyle.

Hanover

Hanover

www.hanoveryachts.com