



Hanover / **305 OUTBOARD**

hanoveryachts.com / 2025



A sporty vessel with the power to conquer the sea at your will.

The Hanover 305 could be your gateway to the boating world, affordable, luxurious, sporty and practical. With an Outboard powerful engine, you will not only generate speed but style, taking you, your friends and family to the best trips at sea, to relax or celebrate the best moments in life.

YOUR BEST BOATING LIFE AWAITS

Hanover



Hanover 305
OUTBOARD

2025



Hanover 305
OUTBOARD

2025



Hanover 305
OUTBOARD

2025

TECHNICAL SPECIFICATIONS



LENGTH

33' 3" / 10.15 m



BEAM

9' / 2.75 m



DRAFT

26" / 0.6 m



DRY WEIGHT

6,265 lbs / 2,842 kg



FUEL TANK CAPACITY

118 gal / 450 L



WATER TANK CAPACITY

27 gal / 100 L



HOLDING TANK

20 gal / 75 L



CAPACITY

12 day / 4 Night



CRUISING SPEED

28-30 mph / 45-48 kmh
Range: 30mph - 14.5 gal/h



WIDE OPEN THROTTLE

42-49 mph / 67-78 kmh
Range: 42mph - 33.5 gal/h



DEADRISE

18°



BRIDGE CLEARANCE

8' 2" / 2.4m



Hanover 305
OUTBOARD

2025

A CABIN

- 1 Acrylic access door with lock and key
- 2 Stainless steel staircase with 2 wide teak steps
- 3 Microwave space
- 4 Decorative mirror on the bow
- 5 U-shaped sofa for 3 people convertible into a double bed
- 6 Double bed amidships
- 7 Compartment under double bed
- 8 Basic layette kit with 2 pillows and 4 cushions

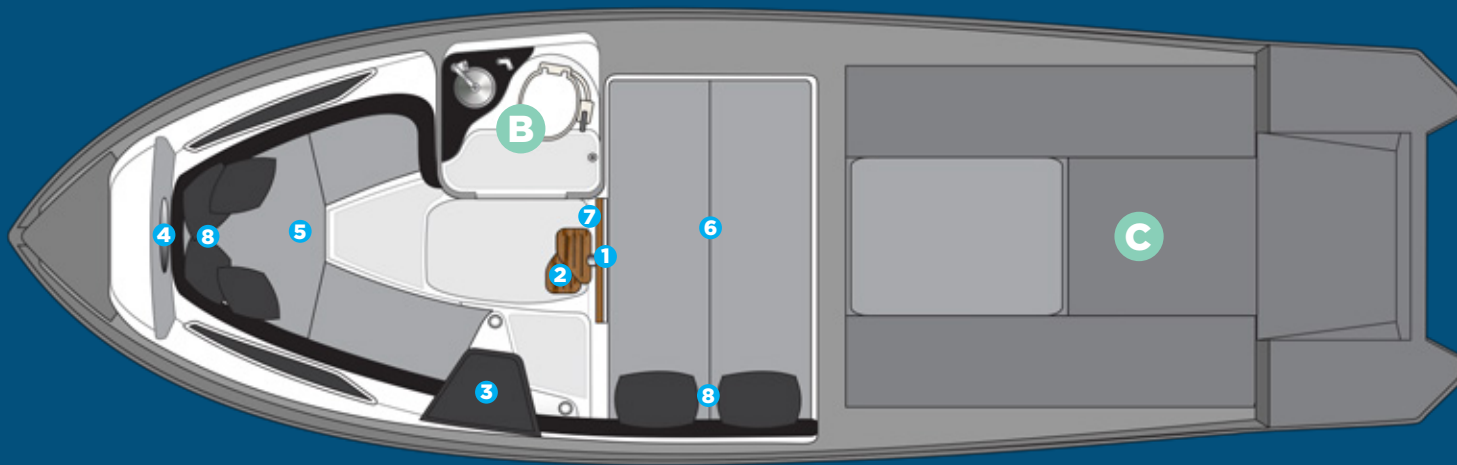

B BATHROOM

- Electric toilet with 80 liter waste box, macerator pump and external nozzle
- Cabinet with one door, synthetic granite sink with stainless steel sink
- Air cabinet with mirrored door
- Non-slip floor
- Hygienic shower

C ENGINE

- Gray gelcoat interior paint
- Non-slip flat floor
- Smoke sensor
- Fire extinguisher
- Sealed battery compartment
- Separate compartment for fuel tank
- Exhaust fan
- Quick access door with gas pistons

HULL AND COCKPIT

- 1** 6 6" stainless steel cleats
- 2** Tall stainless steel rail with teak seat in the bow
- 3** Acrylic hatchway in the bow
- 4** Acrylic hatch
- 5** Instrument panel that supports up to two 9" electronics with built-in compass
- 6** Dual rider seat with leg rest for standing or sitting
- 7** Two sofas in the cockpit
- 8** Chaise on port
- 9** 2 Fixed panoramic windows in acrylic
- 10** 1 Tilting tempered glass window amidships
- 11** Teak table
- 12** Steps to the bow

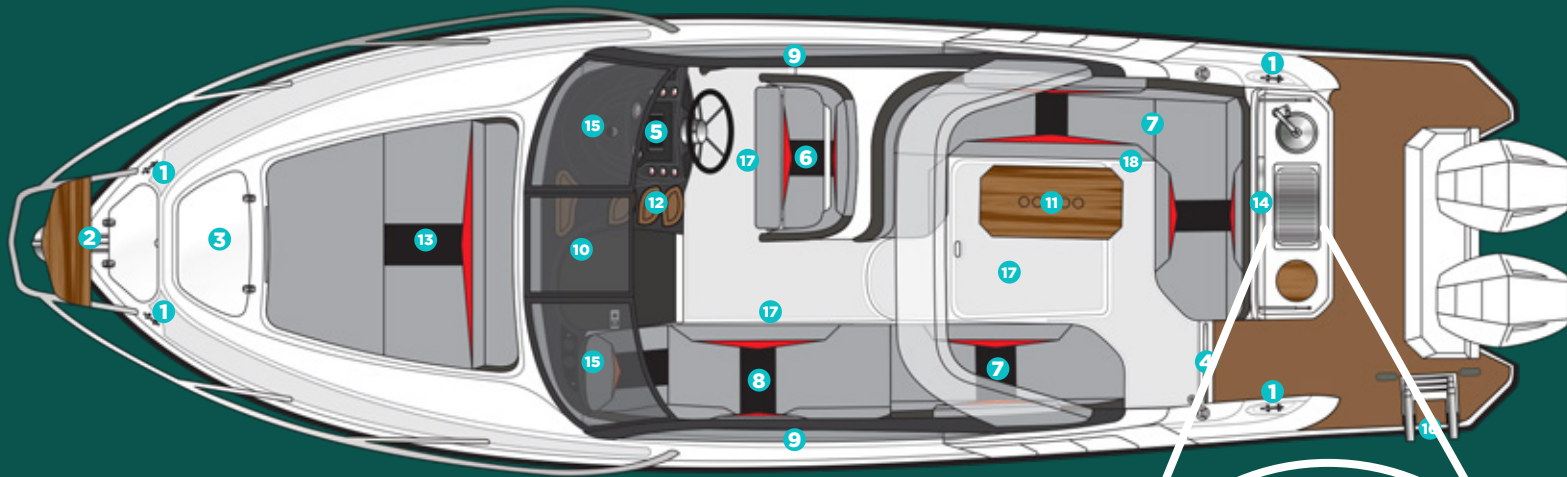

- 13** Bow solarium with headrest
- 14** Gourmet Area or Extra Bed
- 15** Tempered glass windshield and anodized aluminum frame
- 16** 3-Step telescopic ladder on platform
- 17** 3 Compartments below the cockpit seats
- 18** 1 Thermal compartment below the seat

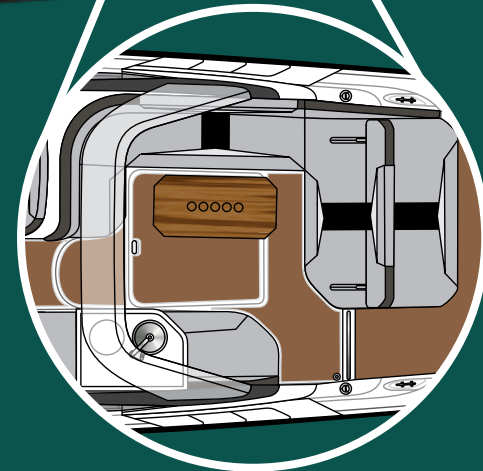

EXTRA BED OPTIONAL LAYOUT

EXTRA BED OPTIONAL LAYOUT





**CUSTOMIZE AND
HAVE THE MOST UNIQUE
VESSEL AT SEA**

Hanover 305
OUTBOARD

2025



EXTERIOR PAINT OPTIONS

All options are available in either a high-gloss or matte finish.

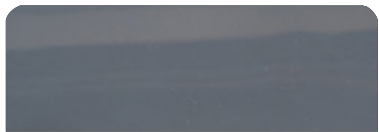

Moonstone Gray

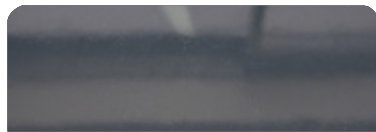

Pure Gray

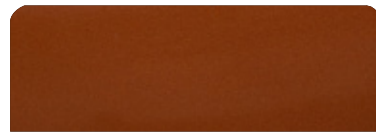

Orange Pearl



Spring Blue



Orkney Gray



Ice Silver



Moscou Red



Heraldic Blue



Crayon Gray

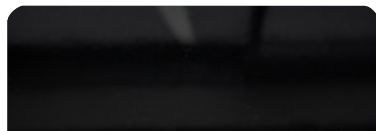

Gales Black (Tuxedo)

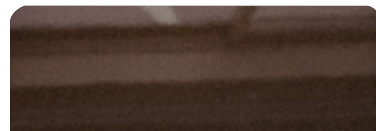

Marrakesh Brown



Macaw Blue



UPHOLSTERY OPTIONS

UPHOLSTERY DESIGN

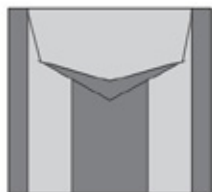

Classic

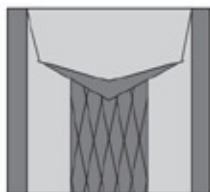

Diamond



Vintage

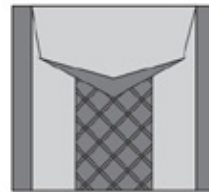

Elegant

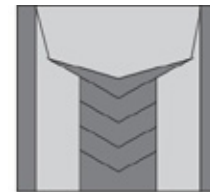

Sporty

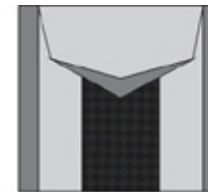

Carbon Fiber

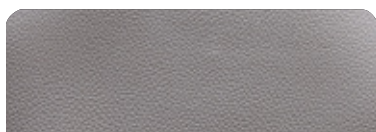

Fern

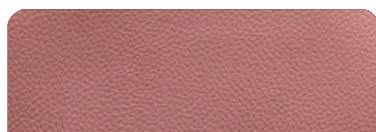

Terracota

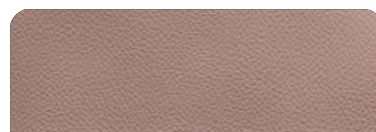

Caramello

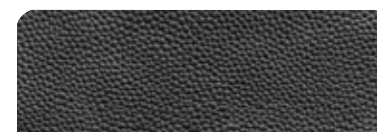

Black

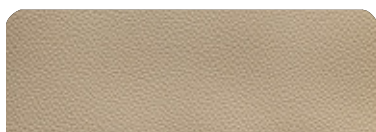

Land Rover

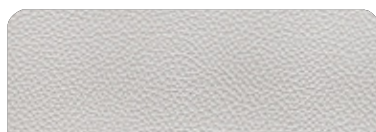

Taupe

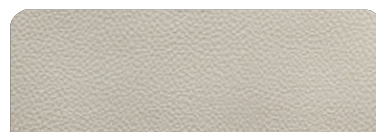

Ivory

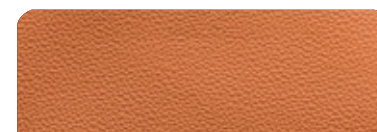

Orange



UPHOLSTERY OPTIONS

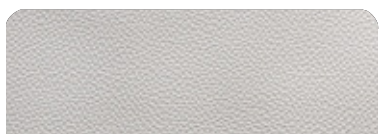

Off White

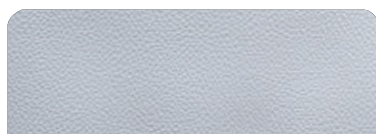

Gray

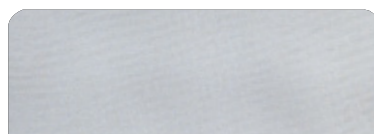

Silver

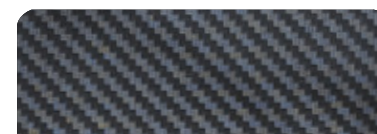

Carbon Fiber

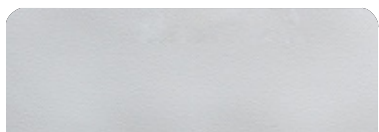

White

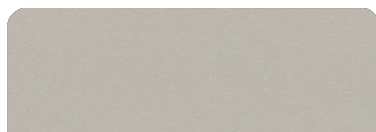

Beige

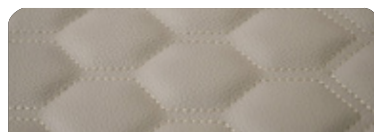

Matelasse Honeycomb

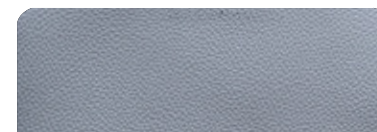

New Corolla

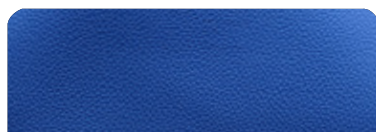

Blue

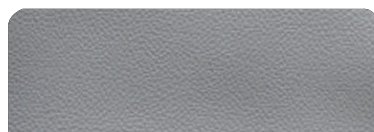

Corolla

FURNITURE VINYL OPTIONS



Salina



Massal

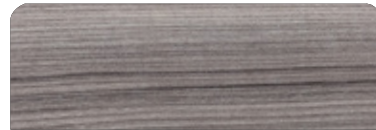

Cherry



Patina

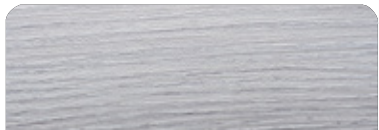

Alder



Bronze

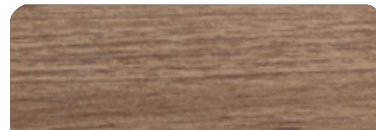

Freije

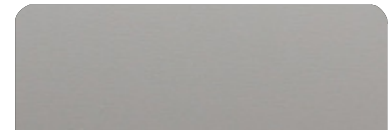

Taupe Super Matte

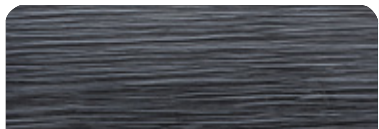

Black Line

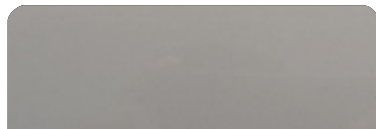

Taupe High Gloss

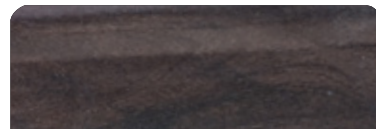

Canyon

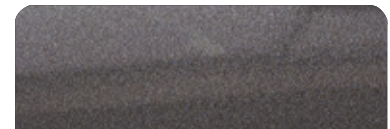

Onix

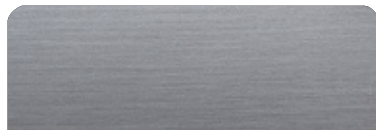

Metallic



Gray Oak

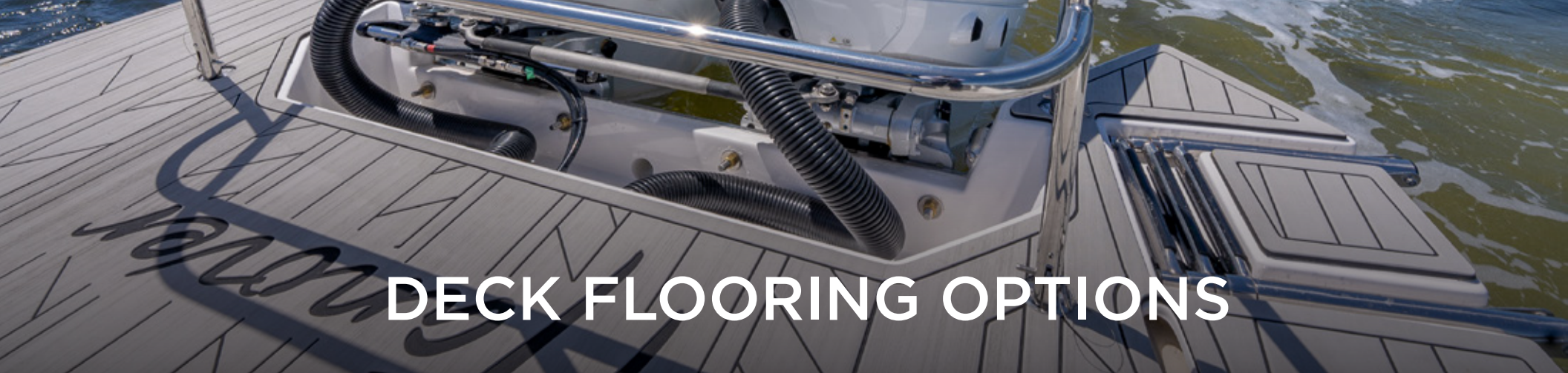

DECK FLOORING OPTIONS

PATTERNS

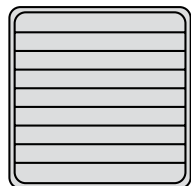

Classic

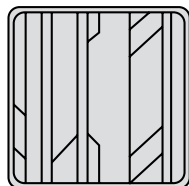

Aztec

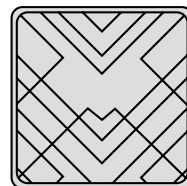

Imperial

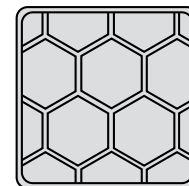

Beehive

EVA

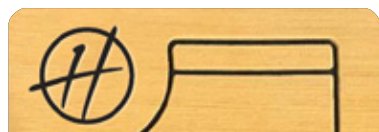

Madeira



Gray



Ocher

SYNTHETIC TEAK



Madeira



Gray



Sand



LUXURIOUS & SPORTY

Get the best of both worlds and make lifelong memories with the Luxurious and Sporty HANOVER 305.

As soon as you start handling the 305 you will know for certain that you've made one of the best decisions of your life.

Hanover 305
OUTBOARD

2025

STANDARD EQUIPMENT

HULL AND DECK

- 6 6" stainless steel cleats
- 1 looked in the bow
- 2 Eyes on the stern
- Tall stainless steel rail with teak seat in the bow
- Anchor support + stainless steel protection plate
- Stainless steel water, fuel and waste water nozzles
- Stainless steel vents, side outlets and manhole
- PVC brace with stainless steel finish
- Acrylic hatchway in the bow
- 2 stainless steel elliptical portholes
- 2 Fixed panoramic windows in acrylic
- 1 tilting tempered glass window amidships
- Tempered glass windshield and anodized aluminum frame
- 3-step telescopic ladder on platform
- Bow solarium with headrest
- Stainless steel grabs in the gourmet space
- 3 compartments below the cockpit seats
- 1 thermal compartment below the seat
- teak table
- Anti-mold nautical corvim upholstery
- Storage, acrylic
- Acrylic cup holders in the cockpit
- White isophthalic gelcoat paint
- Instrument panel that supports up to two 9" electronics with built-in compass
- Dual rider seat with leg rest for standing or sitting
- Two sofas in the cockpit
- Chaise on port
- Stainless steel balustrade at stern (outboard motors only)

CABIN

- Acrylic access door with lock and key
- Stainless steel staircase with 2 wide teak steps
- Furniture in Ultra Moisture resistant MDF
- Microwave space
- 2 compartments under the seats
- Decorative mirror on the bow
- U-shaped sofa for 3 people convertible into a double bed
- Double bed amidships
- Waterproof fabric coverings or anti-mold nautical corvin
- Basic layette kit with 2 pillows and 4 pillows

ENGINE ROOM

- Gray gelcoat interior paint
- Non-slip flat floor
- Smoke sensor
- Fire extinguisher
- Sealed battery compartment
- Separate compartment for fuel tank
- Exhaust fan
- Quick access door with gas pistons
- 316 liter aluminum fuel tank and level gauge

PUMPS AND TANKS

- Drinking water tank with 27 Gallons and external supply
- 1.9 Gph booster pump
- 2 bilge pumps in the engine room with automatic
- 1 bilge pump amidships with automatic
- Aft shower
- Bathroom sink and gourmet area with stainless steel faucets

HEAD

- Electric toilet with 80 liter waste box, macerator pump and external nozzle
- Cabinet with one door, synthetic granite sink with stainless steel sink
- Air cabinet with mirrored door
- Hygienic shower
- Non-slip floor

ELECTRICAL

- Circuit breaker board
- Selector switch for pier/generator/inverter
- Electrical panel in the cockpit with special switches
- BB/BE navigation lights
- Anchoring mast with conjugated strobe
- Indirect LED lighting on the cabin ceiling and display cabinet
- 3 Courtesy lights in the cockpit
- LED spotlights on the bathroom and cabin ceiling
- LED spotlights on the targa
- Pier socket
- Individual master switches for accessory batteries and motors
- Automatic charging relay for batteries
- Emergency departure
- 1 150 Ah battery for accessories
- 2 150 Ah batteries for engines

OPTIONS INCLUDED

- Synthetic Teak or EVA Flooring on Bow, Cockpit & Platform
- Stainless steel railing with teak seat on bow
- Sound System
- Anchor Windlass System - 800w + 7,5g Anchor and 40m Chain
- VHF radio w/ Antenna
- Macerator and holding tank
- Electric boiler system in the toilet
- 12v / USB Sockets on Dashboard and in Cabin
- Electric trim tabs (flaps)
- Pier outlet
- Complete power inverter and charger system + internal ac (220v or 110v)
- Acrylic cup holders
- 2 stools (seats) at platform
- Bow sundeck
- Fenders & Lines
- USCG Boating Safety Kit
- Shore Power Cord

ESSENTIAL PACKAGE

PREMIUM PACKAGE

**TWIN MERCURY® 150HP
EFI OUTBOARDS**

**TWIN MERCURY® 200HP
DTS OUTBOARDS**

Engine

GPS

GPS SIMRAD® GO7 (7")

GPS SIMRAD® GO9 (9")

Sound System

BOSS® SOUND SYSTEM +
6 JBL® Marine Speakers + Amplifier

**FUSION® SOUND SYSTEM +
6 Marine Speakers + Amplifier**

Exterior Painting

1 Color (Hull)

**2 Colors or More
(Hull, Deck or HT)**

Power Charger/Inverter 1800W



VHF Radio w/ Antenna



Synthetic Teak or EVA Flooring



Electric Toilet System



Anchor Windlass Electric System



Electric Trim Tabs (Flaps)



Fenders & Lines



USCG Boating Safety Kit



Shore Power + Shore Cord 30A



Macerator Pump and Holding Tank



Galvanic Isolator (Electrical Protection)	✓	✓
Internal Table (Cockpit)	✓	✓
Exterior Sport Painting and Sport Seats		✓
Design Items Set (Pillows, Beddings, Cushions, Towels, Accessories)		✓
Folding System for Sunbeds (Bow)		✓
Bimini Top Cover		✓
USB Extra Socket		✓
Italian Steering Wheel		✓
Headlights w/ Remote (Cruising Spotlight)		✓
	\$213,235	\$231,650



TOP COVER OPTIONS

\$7,950

FIBERGLASS T-TOP



\$8,350

CANVAS & STAINLESS STEEL TOP



\$4,550

BIMINI TOP

Full Enclosure



\$2,250

BIMINI TOP

Aluminium or Stainless Steel



\$3,950

EISENGLASS ENCLOSURE

For T-Top

UPGRADES

PREMIUM Got ESSENTIAL but want more?
Upgrade to our PREMIUM options.

PREMIUM+ Got PREMIUM but want more?
Upgrade to our PREMIUM+ options.

ENGINES	Mercury® Twin 200hp DTS Outboards	\$5,450 PREMIUM
	Mercury® Twin 225hp DTS Outboards	\$5,000 PREMIUM+
	Mercury® Twin 250hp V8 Outboards	\$20,000 PREMIUM+
	Mercury® Twin 250hp Verado V8 Outboards W/ Joystick Piloting	\$35,800 PREMIUM+
	Mercury® Twin 300hp V8 Outboards	\$26,950 PREMIUM+
	Mercury® Twin 300hp Verado Outboards W/ Joystick Piloting	\$50,000 PREMIUM+
POWER	Power Charger & Inverter 1800w	\$1,000 PREMIUM
	Power Charger & Inverter 3000w	\$1,000 PREMIUM+
VESSEL VIEW	Mercury® Vessel View 4"	\$2,995
	Mercury® Vessel View 5"	\$3,250
	Mercury® Vessel View 7"	\$3,950
	Mercury® Vessel View 9"	\$4,500
NAVIGATION	Raymarine® Element 7s (7")	\$2,250
	Raymarine® Axiom 9" (Including Interface And Connections With Engines)	\$4,950
	Raymarine® Axiom 12" (Including Interface And Connections With Engines)	\$7,950
	SIMRAD® Go7 (7")	\$3,200
	SIMRAD® Go9 (9")	\$4,395
	SIMRAD® Nss12 (12")	\$6,950 PREMIUM+
	SIMRAD® Nss16 (16")	\$8,450 PREMIUM+
	GARMIN® 9"	\$4,995
GARMIN® 12"	\$8,750	

SOUND SYSTEM	Fusion® Marine Sound System Kit + 6 Marine Speakers + Amplifier	\$4,495 PREMIUM
	JL Audio® Kit 1 - Media Master + 6 Speakers + Amp	\$5,950 PREMIUM+
	JL Audio® Kit 2 - Media Master + 8 Speakers + Amp + Subwoofer	\$10,950 PREMIUM+
SOUND ADD-ON	JBL® Marine Speakers (Extra Pair)	\$695
	Fusion® Marine Speakers (Extra Pair)	\$895
	JBL® Marine Amplifier (Extra) (2 Channels)	\$1,395
	Fusion® Marine Amplifier (Extra) (2 Channels)	\$1,595
AIR CONDITIONING	A/C System - 6,000 BTU	\$4,450
	A/C System - 9,000 BTU	\$5,150
	A/C System - 12,000 BTU	\$5,450
	A/C System - 16,000 BTU	\$5,950
	A/C System (Battery Operated) (Mabru)	\$16,500
COMFORT & ENTERTAINMENT	Bow Tent - Front Shade W/ Poles	\$2,250
	Electric Aft Shade (Stobag)	\$5,200
	Manual Aft Shade (Stobag)	\$3,950
	Aft Brackets For Towing Ski Toys	\$1,500
	Aft Tower For Towing Ski Toys	\$1,950
	LED 24" TV Set And Mounting	\$1,095
DRIVERS AIDES	Automatic Tabs Stabilization	\$15,500
	Mc² Quick Gyro Stabilizers (X3)	\$32,500
	Bow Thruster	\$9,500
	Head Lights With Remote (Cruising Spotlight)	\$1,350 PREMIUM
	Automatic & Electric Trim Tabs	\$7,500
	SIMRAD® VHF Radio W/ Antenna	\$925 PREMIUM
	FLIR® Night Vision	\$5,500

DESIGN & PROTECTION

Design Items Set (Pillows, Beddings, Cushions, Towels, Accessories)	\$3,500 PREMIUM
Nylon Complete Branded Boat Cover	\$3,200
Set Of Weatherized Exterior Seat Covers & Helm	\$3,200
Dashboard Cover (Helm)	\$500
Botton Paint - Antifoul Coppercoat Paint	\$7,250
Dashboard Cover (Helm)	\$500
Underwater Lights (Pair)	\$1,895
Engine Protection Railing - Adjustable	\$1,950
Adj Engine Protection Railing W/ 6 Rod Holders	\$2,995
Snap-on Canvas Cover	\$3,500

RADAR

Raymarine® Radar Quantum I	\$6,750
SIMRAD® Radar Halo20+	\$6,750
GARMIN® Radar	\$7,750

GENERATOR (Outboards Only)

ONAN® 5KVA Power Generator	\$25,000
MWM® 6KVA Power Generator	\$26,000

MISC

Additional USB Socket	\$350
Fireboy® - Advanced Anti-fire System	\$9,500
Coastal Flush Kit For Engines	\$950
Microwave 12v	\$750
Boat Trailer	\$12,000
Complete Synthetic Teak Flooring (Cockpit, Stern, Bow, Cabin)	\$5,600
Additional AC Socket	\$350
Hot Water System - Heater (Shower)	\$3,700
Standalone Adj Aft Deck Grill	\$1,295
External Double Painting & Sports Package (2 Or More Colors, Hull, Deck Or Ht)	\$3,020
Kenyon® Electric Grill (Stern)	\$3,750

SHIPPING DIMENSIONS

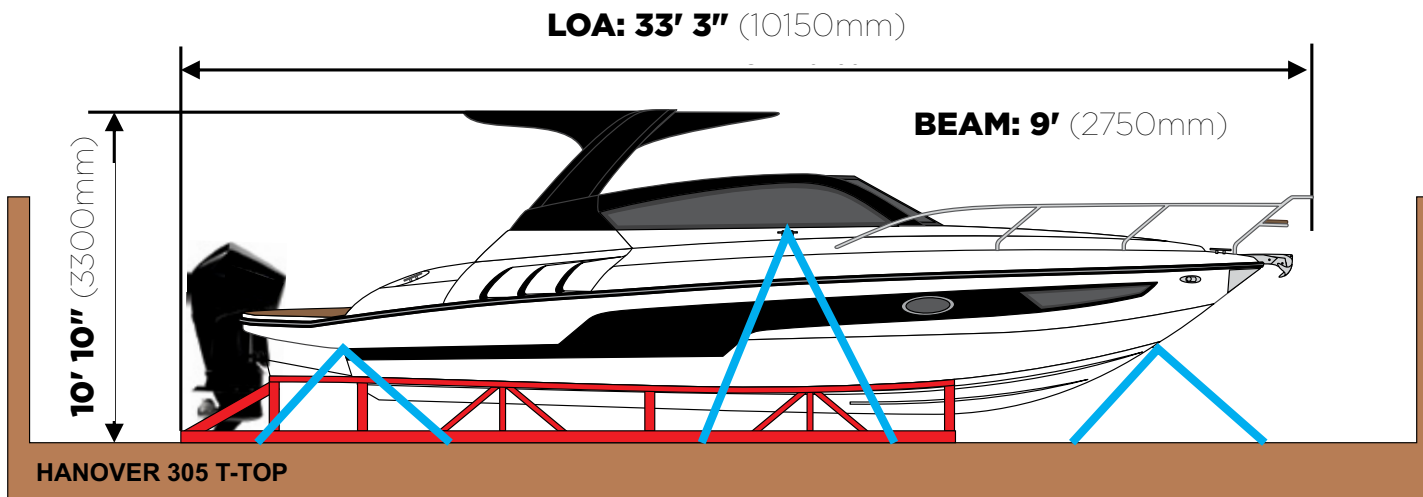
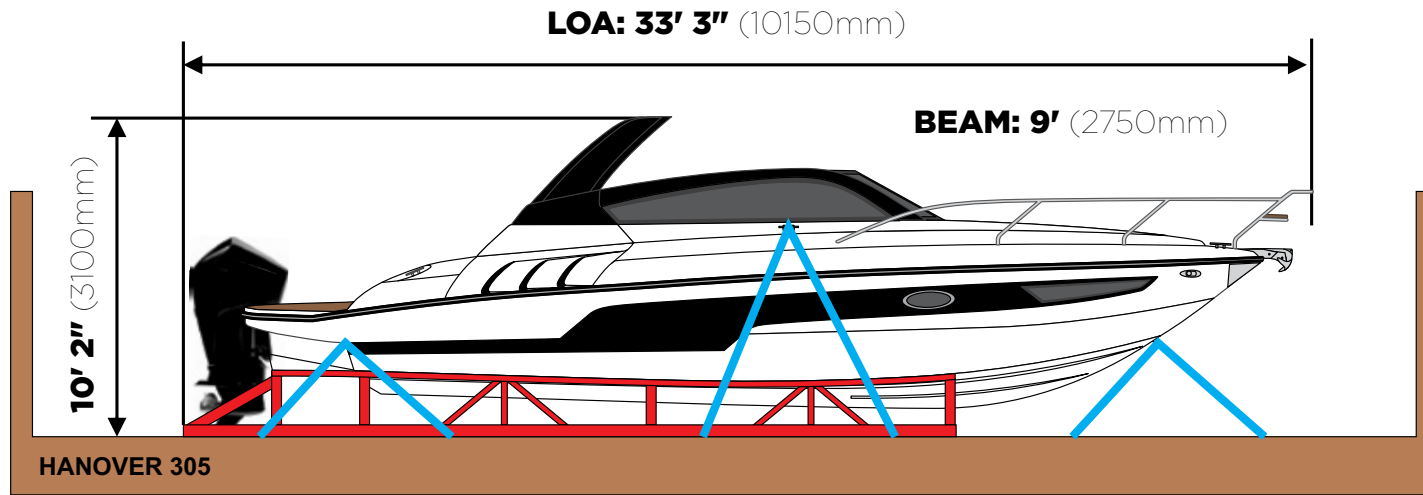

HANOVER OWNERSHIP PROGRAM

At Hanover, we ensure an exciting stress-free experience from the moment you discover our brand.

STRESS-FREE PRICING

Our entire lineup comes at our lowest price - no haggling needed. Leave the negotiations to used car salesmen, and enjoy a straightforward buying experience with us.

FIRST TRIP

We've got you covered - you will get training and your first cruise comes with a captain by your side (up to 4 hours). Feel like a pro and make the most of your experience!

MAINTENANCE AND WARRANTY

Every Hanover vessel includes a 5-Year Premier Level Hull Warranty, 1 Year General, Mechanical and Components Warranty, All Accessories & Electrical Parts Under The Original Manufacturer's Warranty.

Sail with complete confidence knowing you have a team of dedicated professionals at your service.

Don't just own a boat, be part of the Hanover Lifestyle.

Hanover

Hanover

www.hanoveryachts.com