



Hanover / **387 OUTBOARD**

hanoveryachts.com / 2025



First impressions Count, but you don't have to worry about that.
The Hanover 387 Outboard has a sumptuous feel and a Hard-Top that stands out, delivering comfort, the greatest design, and durability, making your voyage truly unforgettable.

MAKE MEMORIES LAST.

Hanover



Hanover 387
OUTBOARD

2025



Hanover 387
OUTBOARD

2025



TECHNICAL SPECIFICATIONS



LENGTH OVERALL

38' 10" / 11.85 m
with outboards & anchor



BEAM

10' 10" / 3.30 m



DRAFT

33" / 0.8 m



DRY WEIGHT

15,220 lbs / 6,904 kg



FUEL TANK CAPACITY

265 gal / 946 L



WATER TANK CAPACITY

50 gal / 190 L



HOLDING TANK

20 gal / 75 L



CAPACITY

15 day / 5 Night



CRUISING SPEED

22-24 mph / 31.3 kph



WIDE OPEN THROTTLE

43-45 mph / 69.2-72.4 kph



DEADRISE

16°



BRIDGE CLEARANCE

10' 7" / 3.2 m
12' 7" / 3.8 m with radar
or anchor light

Hanover 387
OUTBOARD

2025



A CABIN

- 1 Kitchen with sink, synthetic granite top, space for microwave, induction stove, fridge, 3 drawers and two cabinets
- 2 Stainless steel staircase with 3 wide teak steps
- 3 Acrylic access sliding door with lock and key
- 4 High Quality Laminate Flooring
- 5 Decorative mirror on the bow
- 6 U-shaped sofa for 3 people that converts into a double bed, with teak retractable table
- 7 Double bed in the middle ship cabin
- 8 Sofa in the middle ship cabin
- 9 Free standing up of 9' in cabin center

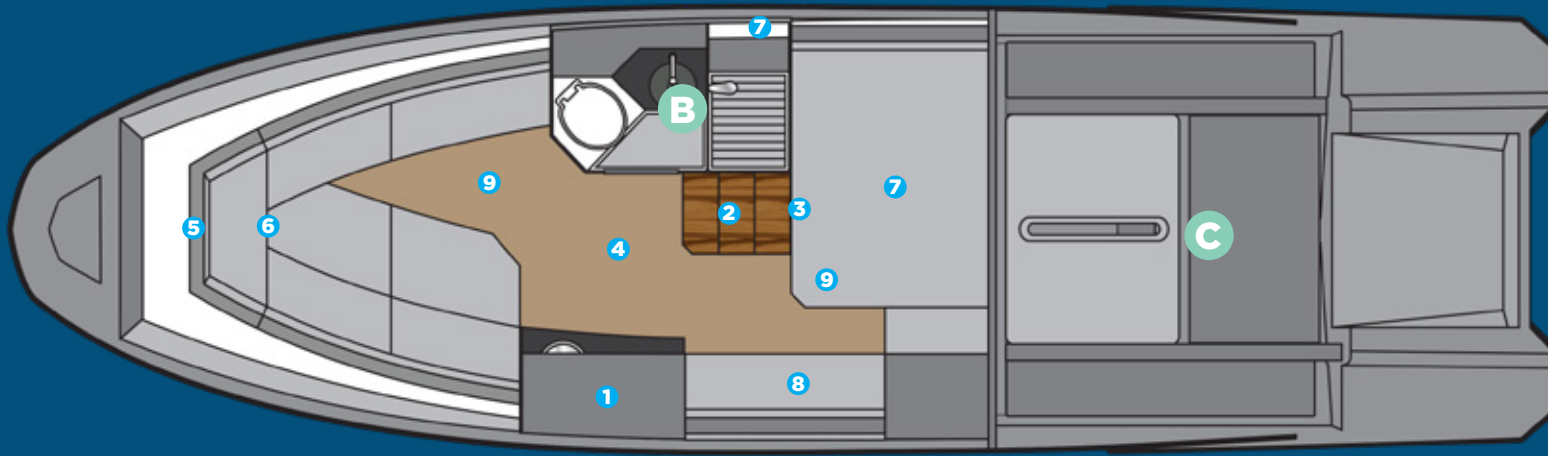

B BATHROOM

- Electric toilet with 22 gallon waste box, macerator pump and external nozzle
- Cabinet with two doors, sink in synthetic granite with bowl overlaid in tempered glass
- Air cabinet with two mirrored doors
- Decorative coating with glass inserts
- Shower box free standing height 6'2" /1,88 min
- Tempered glass box
- Shower with mixer
- Non-slip floor

C ENGINE

- Interior in gray gelcoat
- Non-slip sole, flat
- Insulation, acoustic and thermal
- Fire extinguisher
- Compartment, sealed, for air conditioning
- Compartment, sealed, for batteries
- Exhaust fans (2)
- Engine room hatch
- Access door with gas pistons and lock
- Fuel tank, aluminum, with level gauge

HULL AND COCKPIT

- 1 bow eye
- 2 Stainless steel handrail with teak seat in the bow
- 3 20" hatch in the bow from cabin to bow area
- 4 4 panoramic tempered glass windows
- 5 2 tilting tempered glass windows in the cockpit
- 6 Tempered glass windshield and anodized aluminum frame
- 7 4-step telescopic ladder on platform
- 8 Triple bow solarium with adjustable backrest
- 9 Handle stainless steel in the gourmet space

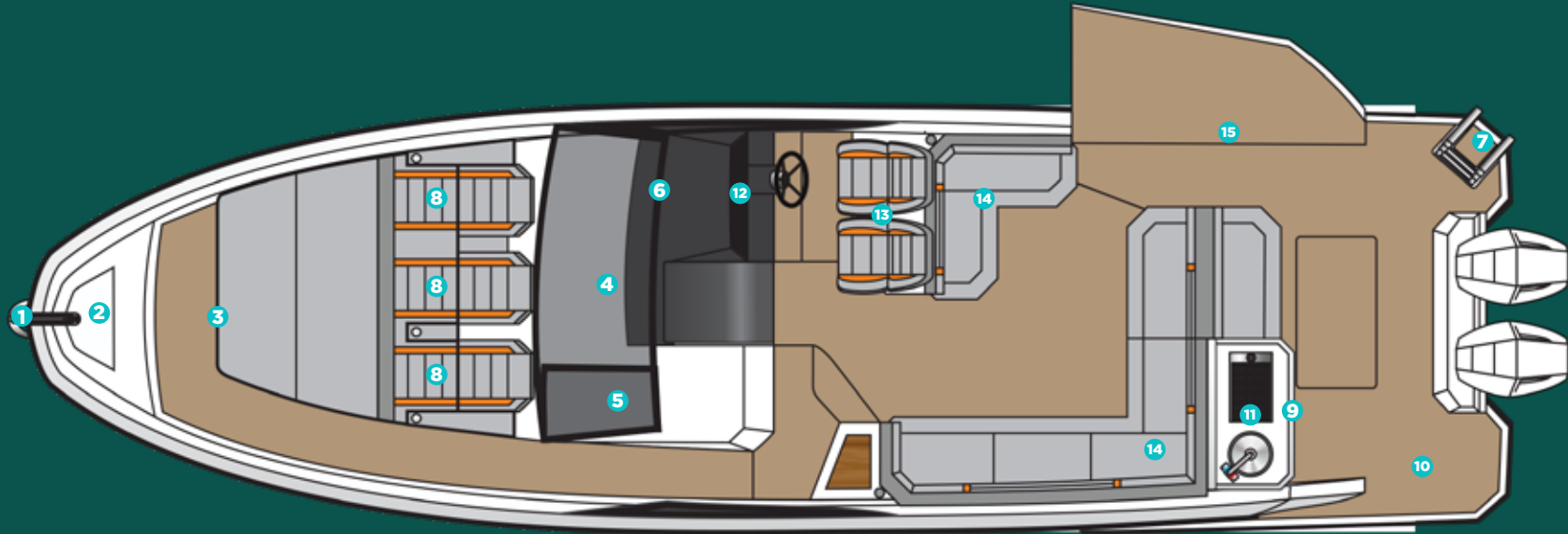

- 10 Teak table
- 11 Gourmet space with top lid and sink
- 12 Instrument panel that supports up to two 9" electronics with built-in compass
- 13 Dual rider seat with standing or sitting
- 14 Two L-shaped sectional sofa in the cockpit and another in the stern
- 15 Electric Opening Lateral Deck - Beach Club System



**CUSTOMIZE AND
HAVE THE MOST UNIQUE
VESSEL AT SEA**



EXTERIOR PAINT OPTIONS

All options are available in either a high-gloss or matte finish.

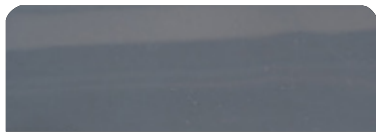

Moonstone Gray

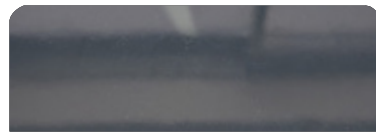

Pure Gray

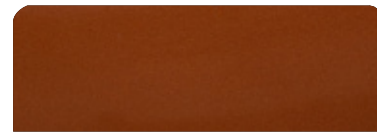

Orange Pearl



Spring Blue

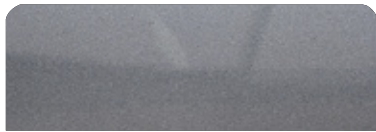

Orkney Gray



Ice Silver



Moscou Red



Heraldic Blue



Crayon Gray

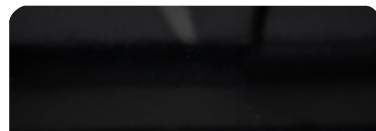

Gales Black (Tuxedo)

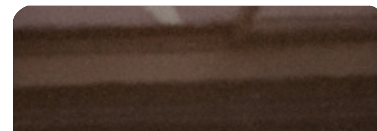

Marrakesh Brown



Macaw Blue

UPHOLSTERY OPTIONS



Fern



Terracota



Caramello

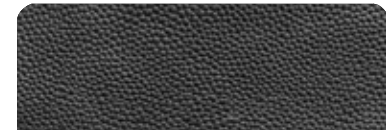

Black



Land Rover



Taupe



Ivory



Orange



Off White



Gray

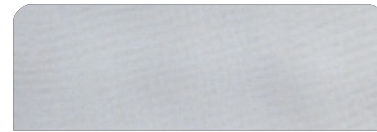

Silver



Carbon Fiber



White

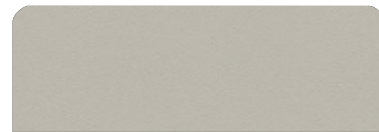

Beige

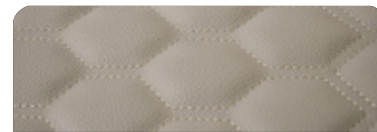

Matelasse Honeycomb



New Corolla



Blue

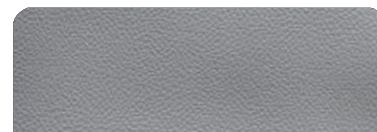

Corolla

FURNITURE VINYL OPTIONS



Salina



Massal

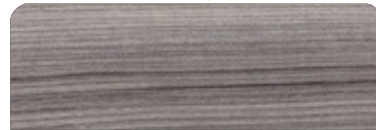

Cherry



Patina

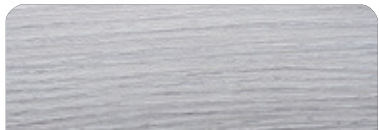

Alder

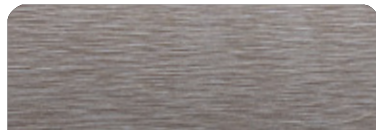

Bronze



Freije

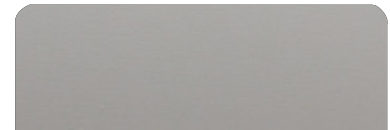

Taupe Super Matte

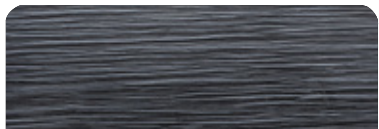

Black Line

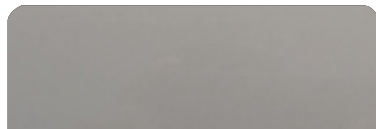

Taupe High Gloss

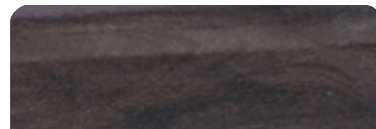

Canyon

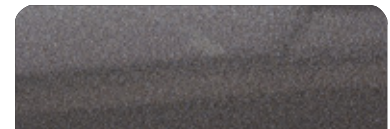

Onix

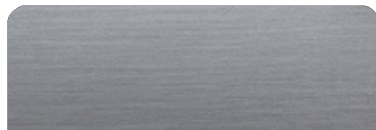

Metallic



Gray Oak

INTERIOR FLOORING OPTIONS



Alba



Almond



Pine



Amendola



Sand



Cement



Imbuia



Cumaru



Gray



Duna



Vintage



Kashmir

DECK FLOORING OPTIONS

PATTERNS

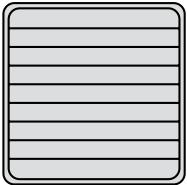

Classic

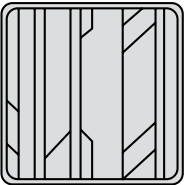

Aztec

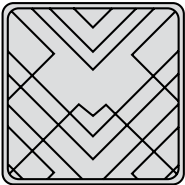

Imperial

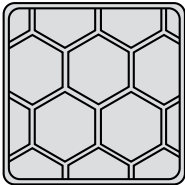

Beehive

EVA



Madeira

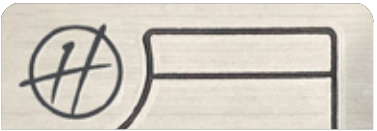

Gray



Ocher

SYNTHETIC TEAK



Madeira



Gray



Sand

PREMIUM COMFORT

There's plenty of room for sunbathing on the bow and a hangout area at the stern, so bring your friends and family; there's only good times on the HANOVER 387.

With the Hard-Top you have convenience and privacy to feel more comfortable while at sea.

Create and share memories that will last a lifetime.
The choice is yours.





STANDARD EQUIPMENT

HULL AND DECK

- 8" through bolted stainless steel cleats (06 count)
- 1 bow eye
- 2 eyes at the stern
- Stainless steel handrail with teak seat in the bow
- Self-draining floor
- 20" hatch in the bow from cabin to bow area
- 4 panoramic tempered glass windows
- 2 tilting tempered glass windows in the cockpit
- Tempered glass windshield and anodized aluminum frame
- 4-step telescopic ladder on platform
- Double bow solarium with adjustable backrest
- Handle stainless steel in the gourmet space
- Compartment for fenders on the platform floor
- 5 compartments below the cockpit seats
- Teak table
- Upholstery in anti-mold leather
- Gourmet space with top lid, sink, fridge, cutting board
- Hard-Top
- Storage, acrylic
- Acrylic cup holder in the cockpit
- Instrument panel that supports up to two 9" electronics with built-in compass
- Dual rider seat with standing or sitting
- Two seating areas in the cockpit
- Cooler
- Garbage Displacement
- Electric Opening Lateral Deck - Beach Club System

HEAD

- Electric toilet with 22 gallon waste box, macerator pump and external nozzle
- Cabinet with two doors, sink in synthetic granite with bowl overlaid in tempered glass
- Air cabinet with two mirrored doors
- Decorative coating with glass inserts
- Shower with mixer
- Tempered glass box
- Shower box free standing height 6'2" /1,88 m
- Non-slip floor

CABIN

- Acrylic access sliding door with lock and key
- Stainless steel staircase with 3 wide teak steps
- Ultra moisture resistant MDF furniture
- Kitchen with sink, synthetic granite top, space for microwave, induction stove, fridge, 3 drawers and two cabinets
- High Quality Laminate Flooring
- Decorative mirror on the bow
- U-shaped sofa for 3 people that converts into a double bed, with teak retractable table
- Double bed in the middle ship cabin
- Sofa in the middle ship cabin
- Coverings in waterproof fabric or anti-mold nautical leather
- Side walls covered with anti-mold foam and nautical leather
- Luxury layette kit with 10 pillows
- Free standing up of 9' in cabin center

ENGINE ROOM

- Interior in gray gelcoat
- Non-slip sole, flat
- Insulation, acoustic and thermal
- Fire extinguisher
- Compartment, sealed, for air conditioning and batteries
- Exhaust fans (2)
- Engine room hatch
- Access door with gas pistons and lock
- Fuel tank, aluminum, with level gauge

PUMPS AND TANKS

- Water tank, potable, 50 gal
- Fresh water pump
- Bilge pumps, engine room, with automatic switches
- Bilge pump, amidships, with automatic switch
- Collection box for shower with pump
- Showerhead, aft, with mixer

ELECTRICAL

- Circuit breaker board
- Selector switch for pier/generator/inverter
- Electrical panel in the cockpit with special switches
- Navigation lights
- Anchoring lights
- Indirect LED lighting on the cockpit ceiling, bathroom, cabin, cabinet and under the sofas and dashboard
- LED spotlights on the cabin and cockpit ceiling
- Lighting in the engine room
- 120v sockets in the cockpit, cabin and bathroom
- 12v / USB sockets on the dashboard and in the cabin
- Shore power socket
- Individual master switches for accessory batteries and motors

OPTIONS INCLUDED

- Synthetic teak or EVA on bow, cockpit and swim platform
- Sound system
- Anchor Windlass Electric System
- Anchor, 22 lbs, with chain
- VHF Radio w/ Antenna
- Sunroof, electric opening
- Holding tank with macerator
- Air conditioning, 12,000 BTU
- Generator
- Refrigerator,
- Trim tabs, electric
- Spotlights
- Shorepower
- Gourmet Area

ESSENTIAL

PACKAGE

**TWIN MERCURY® V8 300HP OUTBOARDS
W/ JOYSTICK PILOTING**

PREMIUM

PACKAGE

**TWIN MERCURY® VERADO 350HP V10
OUTBOARDS W/ JOYSTICK PILOTING**

Engine

GPS

GPS SIMRAD® GO7 (7")

GPS SIMRAD® GO9 (9")

Sound System

BOSS® SOUND SYSTEM +
6 JBL® Marine Speakers + Amplifier

**FUSION® SOUND SYSTEM +
6 Marine Speakers + Amplifier**

Exterior Painting

1 Color (Hull)

**2 Colors or More
(Hull, Deck or HT)**

A/C

12,000 BTU (Cabin)

**12,000 + 6,000 BTU
(CABIN - COCKPIT)**

Refrigerator

Refrigerator - 110V

ISOTHERM® 65L FRIDGE 12V

VHF Radio

Uniden® VHF Radio w/ Antenna

SIMRAD® VHF RADIO W/ ANTENNA

Power Generator Kohler® 6KVA



Complete EVA Flooring



Anchor Windlass Electric System



Electric Trim Tabs (Flaps)



Fenders & Lines



USCG Boating Safety Kit



Shore Power + Shore Cord 50A



Macerator Pump and Holding Tank



Galvanic Isolator (Electrical Protection)	✓	✓
Windshield Wipers	✓	✓
Heavy Duty Folding Table (Cockpit)	✓	✓
Electric Opening Sunroof	✓	✓
Power Charger 100A	✓	✓
Italian Steering Wheel	✓	✓
Headlights w/ Remote (Cruising Spotlight)		✓
LED 24" TV Set and Mounting		✓
Design Items Set (Pillows, Beddings, Cushions, Towels, Accessories)		✓
Teak Table On Stern (Platform Extra Table)		✓
Bar Stools/chairs On Stern (Kit Of 2 Banquets)		✓
Hot Water System - Heater (Shower)		✓
Induction Electric Stove (Cabin)		✓

\$472,915

\$514,115



LAYOUT OPTIONS

Aft-Grill
Included

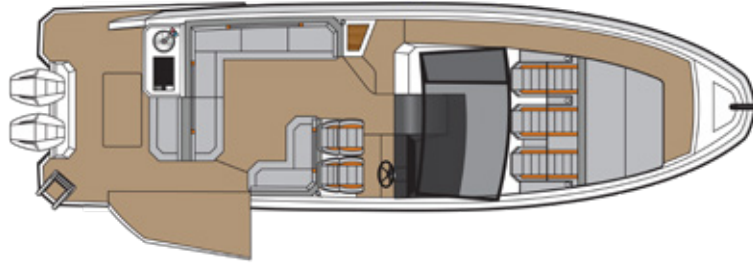

Starboard Kitchen
and Aft-Grill
\$3,350

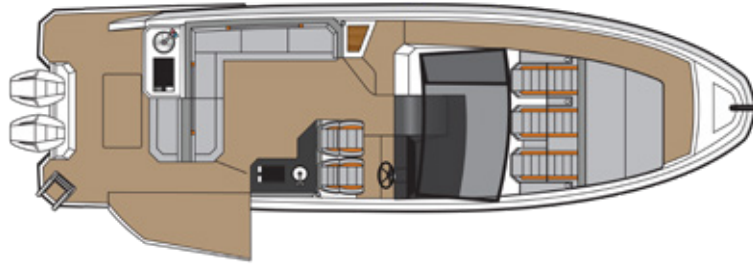

Aft-Sundeck
\$3,750

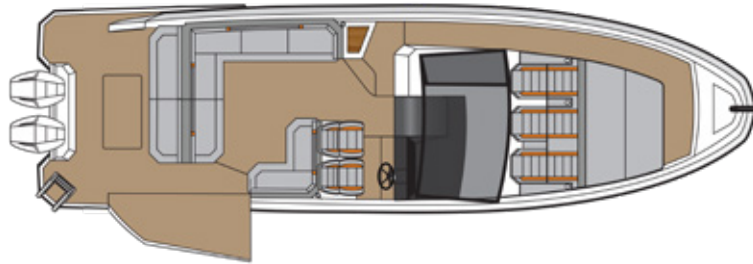

Starboard Kitchen
and Aft-Sundeck
\$4,550

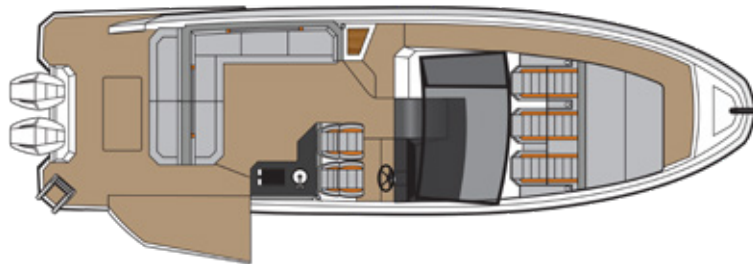

UPGRADES

PREMIUM Got ESSENTIAL but want more?
Upgrade to our PREMIUM options.

PREMIUM+ Got PREMIUM but want more?
Upgrade to our PREMIUM+ options.

ENGINES	Mercury® Twin Verado 350hp V10 Outboards W/ Joystick Piloting	\$30,000 PREMIUM
	Mercury® Twin Verado 400hp V10 Outboards W/ Joystick Piloting	\$10,000 PREMIUM+
VESSEL VIEW	Mercury® Vessel View 4"	\$2,995
	Mercury® Vessel View 5"	\$3,250
	Mercury® Vessel View 7"	\$3,950
	Mercury® Vessel View 9"	\$4,500
NAVIGATION	Raymarine® Element 7s (7")	\$2,250
	Raymarine® Axiom 9" (Including Interface And Connections With Engines)	\$4,950
	Raymarine® Axiom 12" (Including Interface And Connections With Engines)	\$7,950
	SIMRAD® Go7 (7")	\$3,200
	SIMRAD® Go9 (9")	\$4,395
	SIMRAD® Nss12 (12")	\$6,950 PREMIUM+
	SIMRAD® Nss16 (16")	\$8,450 PREMIUM+
	GARMIN® 9"	\$4,995
GARMIN® 12"	\$8,750	
SOUND SYSTEM	Fusion® Marine Sound System Kit + 6 Marine Speakers + Amplifier	\$1,800 PREMIUM
	JL Audio® Kit 1 - Media Master + 6 Speakers + Amp	\$2,000 PREMIUM+
	JL Audio® Kit 2 - Media Master + 8 Speakers + Amp + Subwoofer	\$5,000 PREMIUM+

SOUND ADD-ON

JBL® Marine Speakers (Extra Pair)	\$695
Fusion® Marine Speakers (Extra Pair)	\$895
JBL® Marine Amplifier (Extra) (2 Channels)	\$1,395
Fusion® Marine Amplifier (Extra) (2 Channels)	\$1,595

ENCLOSURE & SHADE

Electric Aft Shade (Stobag)	\$5,200
Manual Aft Shade (Stobag)	\$3,950
Manual Aft Shade W/ 2 Poles	\$2,950
Bow Tent (Bimini Top On Bow)	\$2,450
Eisenglass Enclosure	\$5,500
Mid Ship Cabin Room Enclosure (Wood/door)	\$4,500
Main Cabin Room Enclosure (Wood/door)	\$6,500

AIR CONDITIONING

A/C System - 6,000 BTU (Cockpit)	\$4,750 PREMIUM
A/C System - 9,000 BTU (Cockpit)	\$1,150 PREMIUM+
A/C System - 16,000 BTU (Cabin)	\$500 PREMIUM
A/C System - 25,000 BTU (Cabin)	\$4,000 PREMIUM+

DRIVER AIDES

MC² Quick Gyro Stabilizers (X10)	\$46,500
Bow Thruster	\$14,000
Head Lights With Remote (Cruising Spotlight)	\$1,350
SIMRAD® Radar Halo20+	\$6,750
Raymarine® Radar Quantum II	\$7,250
GARMIN® Radar	\$7,750
SIMRAD® VHF Radio W/ Antenna	\$1,295
Humphree® Automatic Trim Tabs	\$9,250
Zipwake® Automatic Trim Tabs	\$9,950
FLIR® Night Vision	\$5,500

DESIGN & PROTECTION

Design Items Set (Pillows, Beddings, Cushions, Towels, Accessories)	\$4,250
Set of Weatherized Exterior Seat Covers	\$3,500
Dashboard Cover (Helm)	\$495
Snap-on Canvas Cover	\$3,500
Leather Cover Panel (Dashboard Top Part)	\$1,250
Leather Cover Panel (Complete Dashboard & Helm)	\$3,495
RGB Changing Lights (Cockpit)	\$2,750
LED Mirror Upgrade (Bathroom)	\$950
Underwater Lights (Pair)	\$1,895
Upgraded Upholstery (Italian Fabric)	\$3,800

ELECTRONICS

Microwave Oven	\$795
Kenyon Electric Grill (Stern)	\$3,750
Induction Electric Stove (Cabin)	\$795 PREMIUM
LED 24" TV Set And Mounting	\$1,095 PREMIUM
Isotherm® 65L Fridge 12v	\$3,695
Refrigerated 12v Drawer (Cockpit)	\$2,950
Isotherm® Ice Maker (Cabin)	\$3,975 PREMIUM
Hot Water System - Heater (Shower)	\$3,700 PREMIUM
Additional USB Extra Socket	\$350

POWER

Kohler® 9KW Power Generator	\$2,500 PREMIUM
Kohler® 11KW Power Generator	\$6,000 PREMIUM+

FLOORING

Standard Fiberglass Flooring (Cockpit, Platform, Bow)	-\$3,200
Synthetic Teak Flooring (Cockpit, Platform, Bow)	\$995

SEATING & TABLE

Teak Table On Stern (Platfrom Extra Table)	\$975 PREMIUM
Adjustable Driver Single Seat - Electric	\$3,065
Adjustable Driver Single Seat - Manual	\$1,395
Bar Stools/chairs On Stern (Kit Of 2 Banquets)	\$1,250 PREMIUM
Upholstered Bar Stools/chairs On Stern (Kit Of 2 Banquets)	\$500 PREMIUM+

ADDITIONAL OPTIONS

Fireboy® - Advanced Anti-fire System	\$9,500
Boat Trailer	\$19,000
External Double Painting (2 Or More Colors, Hull, Deck Or Ht)	\$5,500 PREMIUM
Botton Paint - Antifoul Coppercoat Paint	\$9,500
Adj Engine Protection Railing W/ Rod Holders	\$3,400
Adj Engine Protection Railing	\$2,950
Livewell (Cockpit)	\$1,950
Removable Ladder (Beach Club)	\$825

SHIPPING DIMENSIONS

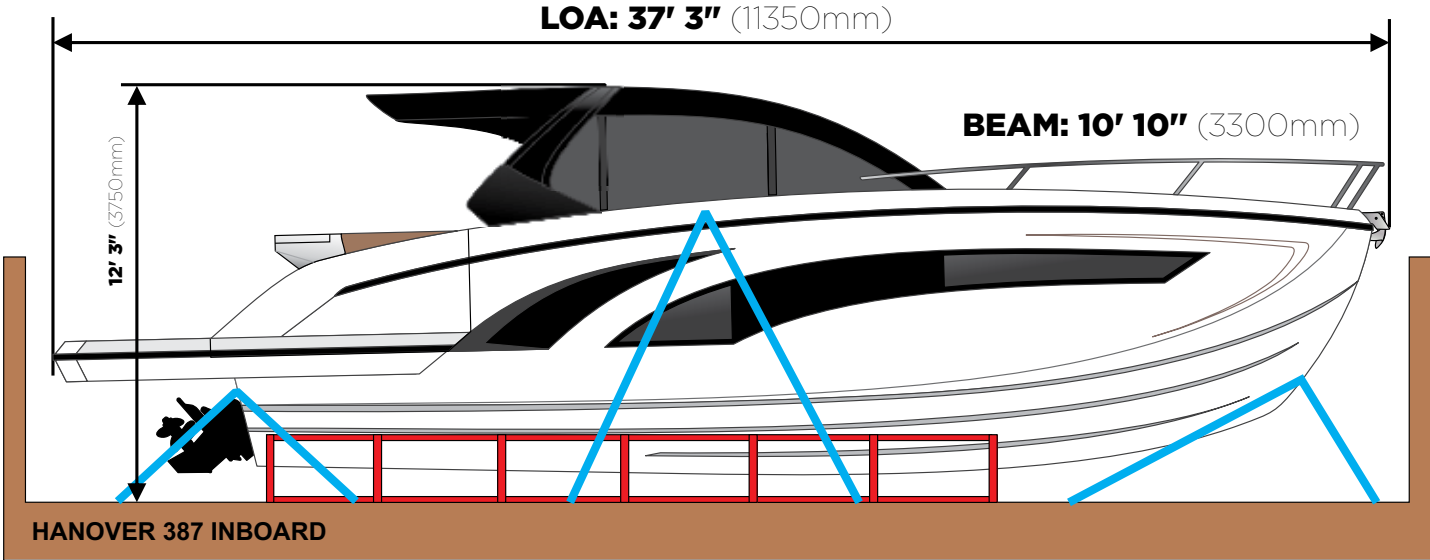
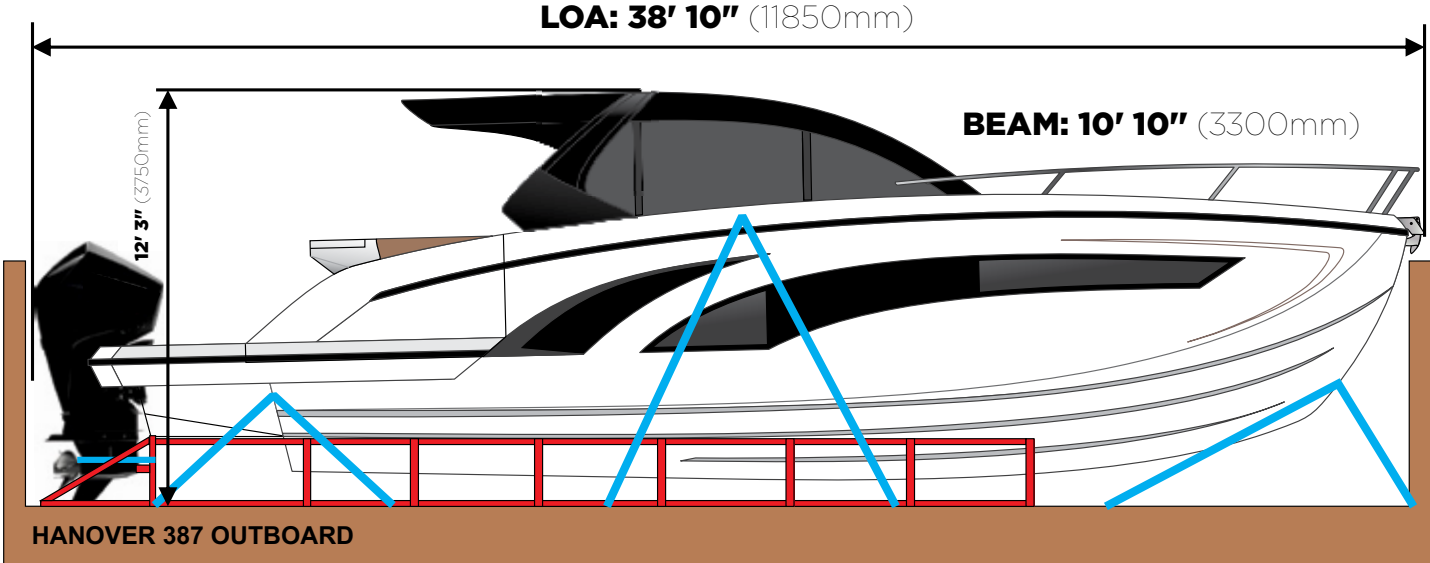

HANOVER OWNERSHIP PROGRAM

At Hanover, we ensure an exciting stress-free experience from the moment you discover our brand.

STRESS-FREE PRICING

Our entire lineup comes at our lowest price - no haggling needed. Leave the negotiations to used car salesmen, and enjoy a straightforward buying experience with us.

FIRST TRIP

We've got you covered - you will get training and your first cruise comes with a captain by your side (up to 4 hours). Feel like a pro and make the most of your experience!

MAINTENANCE AND WARRANTY

Every Hanover vessel includes a 5-Year Premier Level Hull Warranty, 1 Year General, Mechanical and Components Warranty, All Accessories & Electrical Parts Under The Original Manufacturer's Warranty.

Sail with complete confidence knowing you have a team of dedicated professionals at your service.

Don't just own a boat, be part of the Hanover Lifestyle.

Hanover

Hanover

www.hanoveryachts.com